

IP RECEIVER

Model GRx8-32

Instruction Manual



860 boul. de la Chaudière, suite 200
Québec (QC), Canada, G1X 4B7
Tel.: +1 (418) 877-4249
Fax: +1 (418) 877-4054
E-Mail: gdd@gdd.ca
Web site: www.gdd.ca

Visit our web site at:

WWW.GDD.CA

To:

- Discover GDD's new products.
- Download the latest version of the Instruction Manual.
- Comment on or ask questions about products.

TABLE OF CONTENTS

1.	<i>Introduction</i>	5
2.	<i>Receiver Accessories</i>	6
3.	<i>Receiver Components</i>	8
4.	<i>Power</i>	11
5.	<i>Quick Start Guide</i>	14
6.	<i>RS232/Bluetooth Communication</i>	22
7.	<i>Cold weather and harsh environments tips</i>	23
8.	<i>Tools Menu</i>	24
8.1	<i>Config option</i>	26
8.1.1	<i>Setup</i>	26
8.1.2	<i>Position</i>	28
8.1.3	<i>Windows</i>	30
8.1.4	<i>Synchronization</i>	35
8.2	<i>Special option</i>	38
8.2.1	<i>Reinit</i>	38
8.2.2	<i>Simulation</i>	39
8.2.3	<i>Signal Processing Options</i>	43
8.2.4	<i>Battery type</i>	44
8.2.5	<i>Open Port</i>	46
8.3	<i>Show option</i>	47
8.3.1	<i>Hotkeys</i>	47
8.3.2	<i>Pseudosection</i>	48
8.3.3	<i>Signal</i>	50
8.3.3.1	<i>Tools menu</i>	52
8.3.3.1.1	<i>Auto Correction</i>	52
8.3.3.1.2	<i>Restore</i>	52
8.3.3.1.3	<i>PAUSE/GO</i>	53
8.3.4	<i>Contact and Noise</i>	53
8.3.5	<i>Vp and Cycle</i>	54
8.3.6	<i>Show M and errM</i>	55
8.3.7	<i>Decay Curve</i>	56
8.3.8	<i>Show Windows</i>	57
8.3.9	<i>Show Sp</i>	58
8.4	<i>Raw Data Option</i>	59
8.4.1	<i>Check GPS</i>	59
8.4.2	<i>Start Recording (raw data)</i>	62
8.5	<i>Memory Option</i>	65
8.5.1	<i>Display Reading</i>	65
8.5.2	<i>History</i>	66
8.5.3	<i>Back Mem</i>	67
8.5.4	<i>Clear Mem</i>	68
8.5.5	<i>Save File</i>	69
8.6	<i>About Option</i>	72
9.	<i>Transferring data</i>	73

9.1	ActiveSync	73
9.1.1	Installation and settings	73
9.1.2	Establishing connection with a desktop PC.....	74
9.1.3	Transferring file(s) from the Allegro ² to a desktop PC.....	75
9.2	Windows Mobile Device Center.....	77
9.2.1	Installation and settings	77
9.2.2	Establishing connection with a desktop PC.....	78
9.2.3	Transferring file(s) from the Allegro ² to a desktop PC.....	79
9.3	USB connection.....	81
10.	<i>Bluetooth configuration</i>	83
11.	<i>GDD Rx software update</i>	87
12.	<i>Troubleshooting.....</i>	89
13.	<i>Specifications.....</i>	95
13.1	General specifications	95
13.2	Technical specifications.....	95
14.	<i>Technical help</i>	97
<i>Annex 1 – Geometrical parameters.....</i>		98
<i>Annex 2 – 3D Survey.....</i>		104
<i>Annex 3 – Field survey setup.....</i>		116
<i>Annex 4 – Example Dump File (.gdd format)</i>		138

1. Introduction

The highly sensitive GDD IP Receiver models GRx8-32 is a compact unit designed for high productivity resistivity and time-domain induced polarization (IP) surveys in mineral exploration, groundwater exploration, geotechnical investigations and other related fields. It features high capabilities allowing it to work in any field conditions. It can be configured for multi-pole or multi-dipole reception. The receiver uses a rugged field PC to process data acquisition and the software can easily be updated via internet.

Characteristics:

- **Reception poles/dipoles:** 8 poles/dipoles, expandable to 32, for dipole-dipole, pole-dipole or pole-pole arrays.
- **Programmable windows:** The GRx8-32 offers twenty fully programmable windows for higher flexibility in defining the IP decay curve.
- **User modes available:** Arithmetic, logarithmic, semi-logarithmic, Cole-Cole and user defined.
- **IP display:** Chargeability values, Apparent Resistivity, IP decay curves and pseudosections can be displayed in real time thanks to the TFT VGA screen. Before data acquisition, the GRx8-32 can be used as a one channel graphic display for monitoring the noise level and checking the primary voltage waveform through a continuous display process.
- **Internal memory:** Capacity to store up to 64 000 readings for 8 poles/dipoles, memory expandable to 512 000 readings on the PDA model. Each reading includes the full set of parameters characterizing measurements. Data is stored on flash type memory that does not require any lithium battery for safeguard purposes.
- **Full wave data with IP Post-Processing software:** The GRx8-32 records and saves the full wave data (*.mem file). This raw data can be imported, visualized and processed using GDD's IP Post-Processing software.

2. Receiver Accessories

A	1x	IP Receiver, model GRx8-32
B	1x	UART programming adapter (<i>Boot Loader</i>)
C	1x	Allegro ² field computer with a 10.6Ah rechargeable Li-Ion battery and an adjustable hand strap
D	1x	Allegro ² capacitive stylus with tether
E	1x	Allegro ² Holster case
F	1x	Allegro ² wall charger with international plug kit
G	1x	IP Receiver charger (<i>power supply</i>) with international plug kit
H		Blue cables with black banana connectors or red banana connectors
I	1x	Standard serial communication cable
J	2x	Rugged serial communication cables (<i>Amphenol connector</i>)
K	2x	Micro USB Communication Cables
L	1x	External GPS antenna (SMA connector)
M	1x	GDD-BP02 External battery pack (<i>optional for 8 to 16 channels receivers</i>)
N	1x	Input signals connector (41 positions) - Optional
O	1x	Allegro ² Quick Start Guide
P	1x	GDD Instruction manual
Q	1x	Screwdriver
R	1x	IP Receiver documentation CD / USB stick

Not shown on the illustration:

1x Blue carrying case

1x GDD-RTE01 communication box with USB cable (optional accessory)

1x GDD IP Post-Processing Software User Guide

Optional accessories:

GDD-BP02 External battery pack (*for 8, 10 to 16 channels receivers*)

GDD-RTE01 communication box with USB cable

Input signals connector (41 positions)

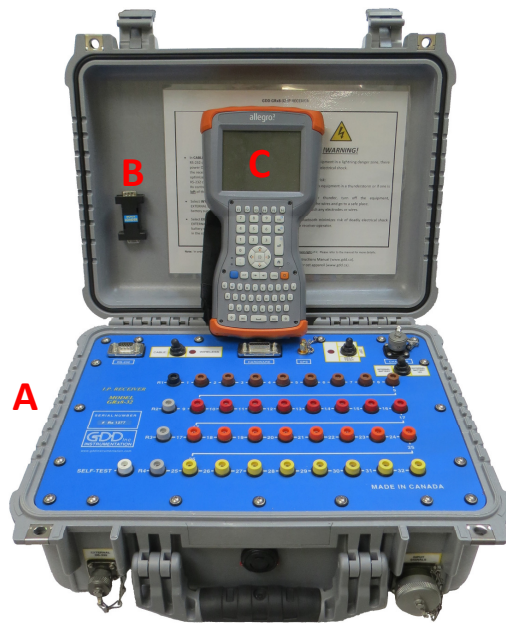

The items supplied with the device and available accessories may differ from the picture.



3. Receiver Components

The GRx8-32 components are described in this section.

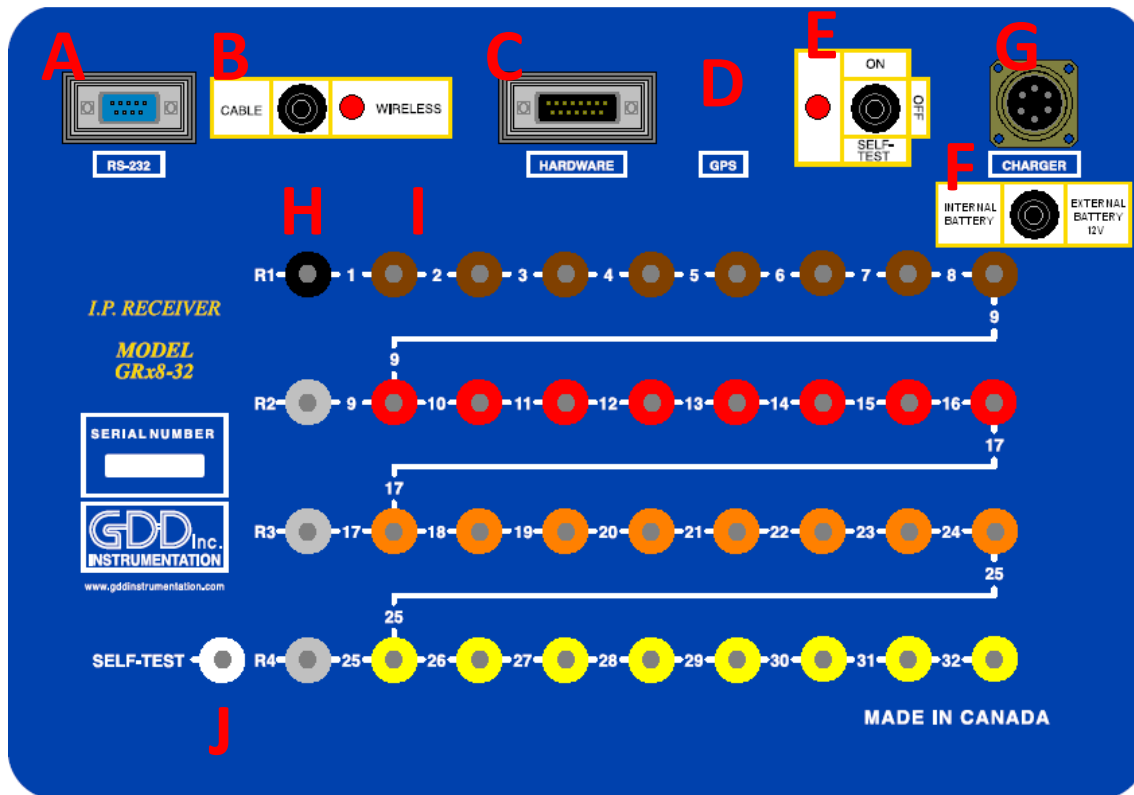

A - RS-232 connector - 9 pin serial communication port

This connector is used to connect the RS-232 cable between the Allegro² and the GRx8-32.

B - CABLE/WIRELESS switch

This switch is used to select CABLE (RS-232) or WIRELESS (Bluetooth) communication with the PDA. The red light indicates that the switch is in the WIRELESS position.

C - HARDWARE connector - 15 pin programming port

This connector is used to update the CPU and PLD software.

D - GPS Connector

This connector is used to connect an external GPS antenna (SMA).

E - ON/OFF/SELF-TEST switch

This switch is used to turn the GRx8-32 ON or to perform a self-test. The red light indicates that the GRx8-32 is ON or in the SELF-TEST position.

F - INTERNAL/EXTERNAL BATTERY switch

This switch is used to select the internal batteries or the external battery pack, provided by GDD.

G - CHARGER connector

This connector is used to charge the receiver batteries. The *Internal Battery / External Battery (F)* switch must be on *Internal battery*.

H - R1 to R4 terminals

In pole configuration, the reference terminals (R1 to R4) are the infinite electrodes. In dipole configuration, the reference terminal is the first electrode in differential with the second electrode.

I - NUMBERED terminals

These terminals are referenced to the Ref terminal (Ref is infinity in pole configuration). In dipole configuration, the numbered terminals are differential terminals.

J - SELF-TEST terminal

This terminal is used to perform a self-test.

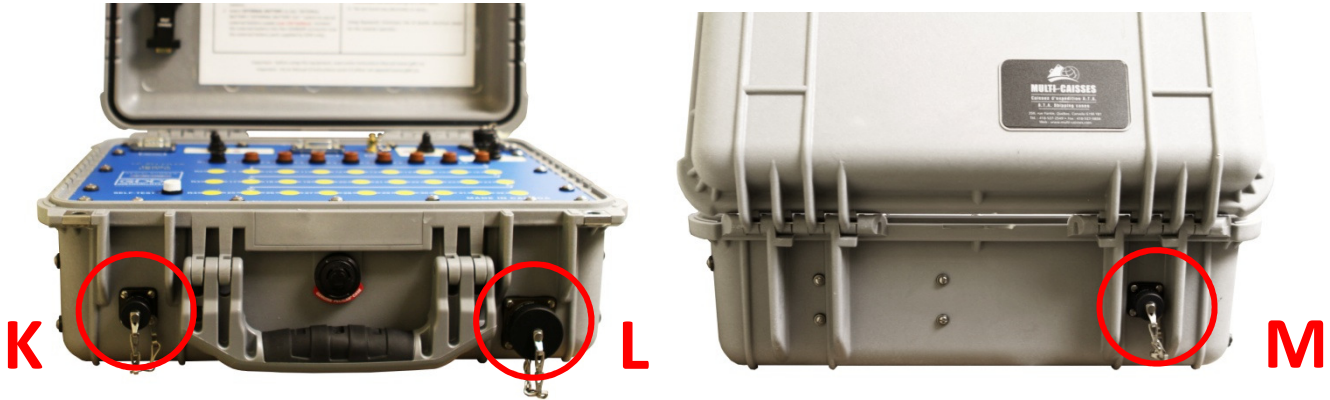

K - RS-232 external Connector

This connector is used to connect the rugged serial communication cable (Amphenol connector), which allows communication between the Allegro² and the GRx8-32 receiver.

L - Input signal connector

This connector is used to connect the wires coming from the electrodes to the receiver channels to keep the Pelican case closed while taking the readings. An optional cable mount connector (41 pos.) can be purchased and used with the instrument.

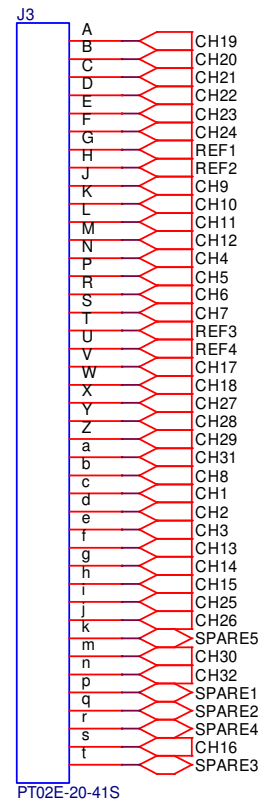
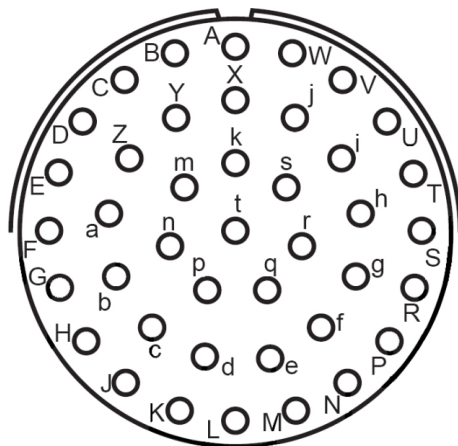

M - External battery connector

This connector is used to connect the external battery pack. The Internal/External battery switch (F) must be on External battery position.

4. Power

GDD's IP Receiver, model GRx8-32, is powered by internal rechargeable Nickel Cadmium / Lithium-ion batteries or an external rechargeable Nickel Cadmium / Lithium-ion battery pack.

Refer to your receiver's charger to find out which type of batteries your receiver has.

Ni-CD batteries



Li-Ion batteries



The power level of the Rx internal batteries is indicated on the main screen of the Allegro² of the GDD Rx software.

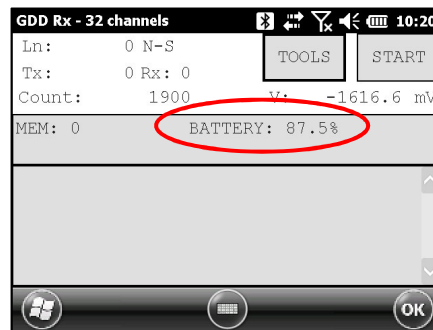

Here are a few tips for using and storing your **lithium-ion** powered receiver:

Usage

- Using a different battery power supply than the one supplied by GDD could damage the batteries and the receiver.
- The connector located on the back of the receiver is used to connect the External Battery Pack supplied by GDD. Connecting other external batteries using this connector could damage the batteries and the receiver.
- Do not replace the receiver's internal batteries without authorization and advice from GDD's technicians.

- The total operating time of the receiver depends on environmental conditions. Using the receiver in very cold weather (-20°C to -40°C) will lower the operating time.
- The receiver will turn itself off when the batteries reach a critical level.
- To extend battery life, avoid frequent full discharge and charge more often between each use.
- A LED under the *Internal battery* switch on the receiver is red when the batteries are charging. It turns off once the batteries are fully charged.

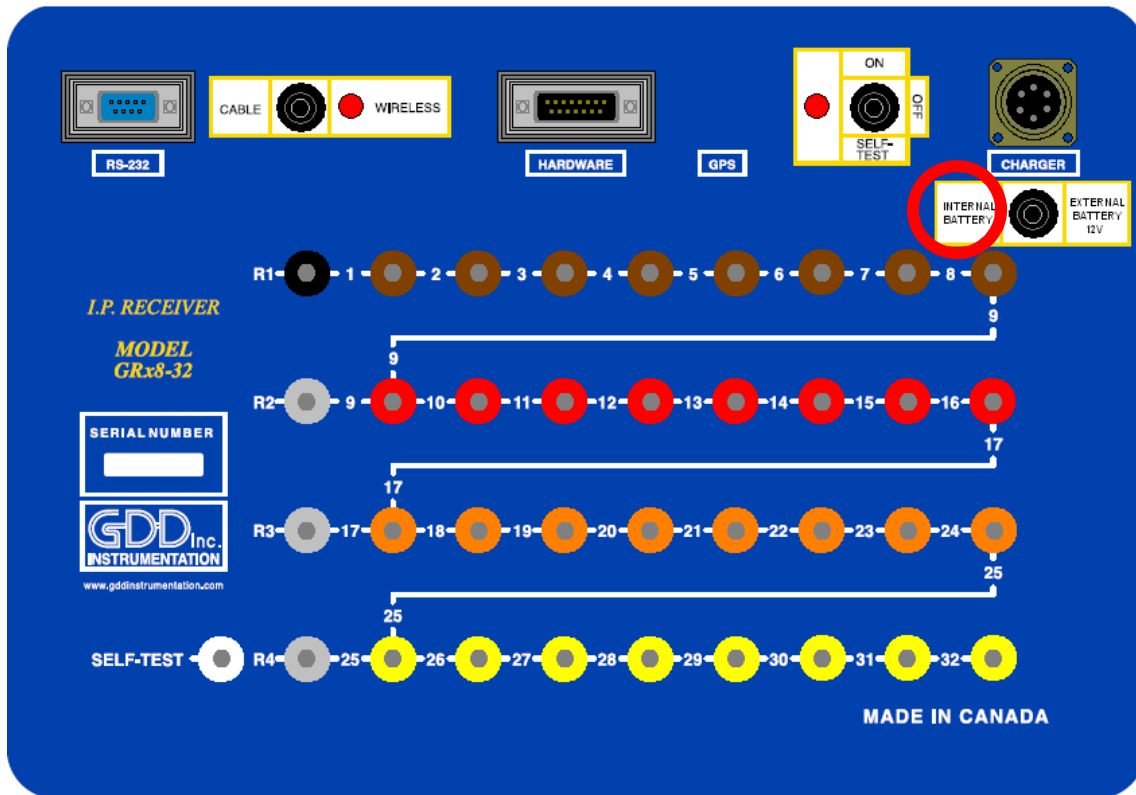

Storage

- To avoid permanent capacity loss, store the receiver and the external battery pack at 40% charge.
- Store the receiver and the external battery pack in a cool, dry place.
- Place the “Internal battery / External battery” switch on “External battery” position to minimize self-discharge of the batteries.
- If stored for several months, check the battery charge level every six months and recharge them to 50% if they are below 30% charge.
Never store fully charged or completely discharged Lithium-Ion batteries for an extended period of time.

Here are a few tips for using and storing your **Ni-CD** powered receiver:

Usage

- **Using a different battery power supply than the one supplied by GDD could damage the batteries and the receiver.**
- **The connector located on the back of the receiver is used to connect the External Battery Pack supplied by GDD. Connecting other external batteries using this connector could damage the batteries and the receiver. If the receiver does not have the external battery pack connector, use the Charger connector to connect the External battery pack.**
- **Do not replace the receiver internal batteries without the authorization and advice from GDD's technicians.**
- The total operating time of the receiver will depend on the environmental conditions. Using the receiver in very cold weather (-20°C to -40°C) will lower the operating time.
- The receiver will turn itself off when the batteries reach a critical level.
- To extend battery life, avoid frequent full discharge and charge more often between uses.

Storage

- To avoid permanent capacity loss, store the receiver and the external battery pack at 40% charge.
- Store the receiver and the external battery pack in a cool and dry place.
- Place the “Internal battery / External battery” switch on “External battery” position to minimize self-discharge of the batteries.
- If stored for several months, check the batteries charge level every six months and recharge them up to 50% if they are below 30% charge.

5. Quick Start Guide

1. Connect electrodes into terminals.
2. Turn ON the IP receiver using the ON/OFF switch on the GRx8-32 panel.
3. Select the communication mode using the CABLE/WIRELESS switch on the GRx8-32 panel.
In CABLE mode, the red light will turn ON only when the GRx8-32 software is active.
4. Connect the rugged serial communication cable (Amphenol connector) between the Allegro² (COM1) and the GRx8-32 RS-232 external connector (CABLE communication only).
5. Turn ON the Allegro² with the ON/OFF button.



6. Click GDD RX.

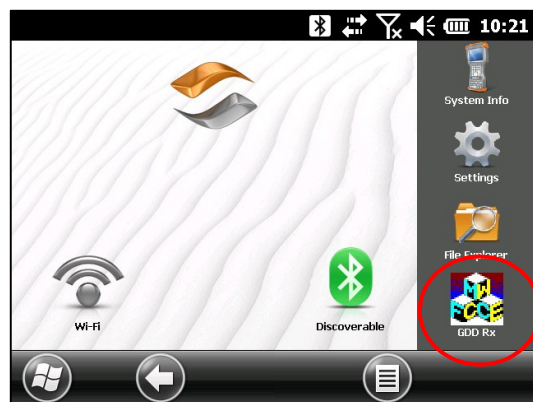

7. Select the communication mode: *RS-232 (CABLE)* or *BLUETOOTH (WIRELESS)*.

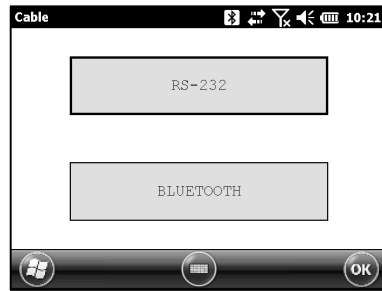

8. The following screen appears.

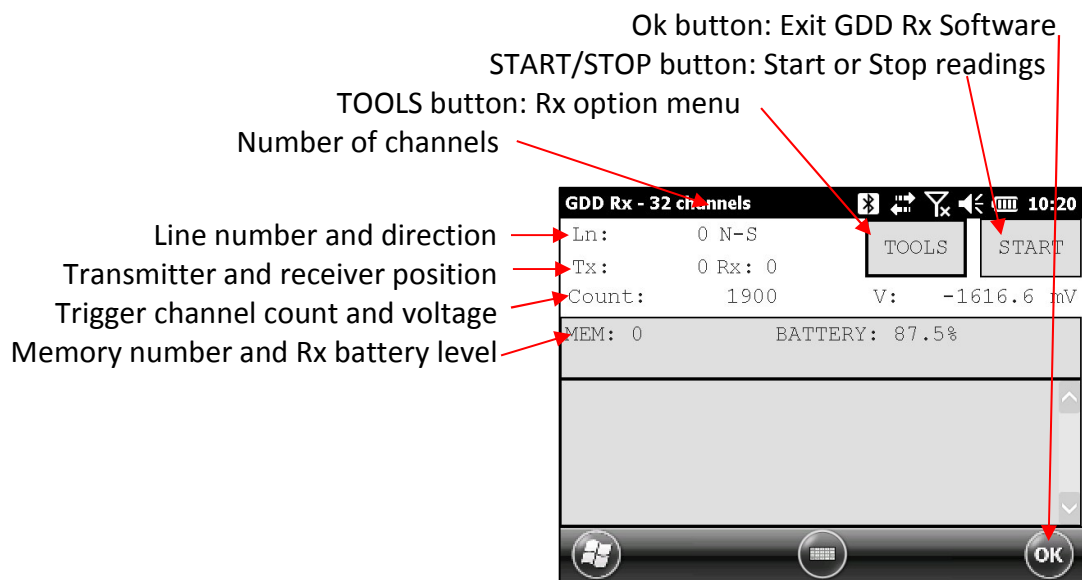

9. Click *START* or press Enter keystroke to begin the acquisition procedure.

Note: If you want to start the process by using the same settings than those of the previous acquisition procedure, press F5 button. You have to start the first acquisition normally before being able to use F5 for the next acquisitions. Using F5 will skip all configuration and contact resistance windows. If F1 to F5 keystrokes do not work on your Allegro², see *Section 12 – Troubleshooting*.

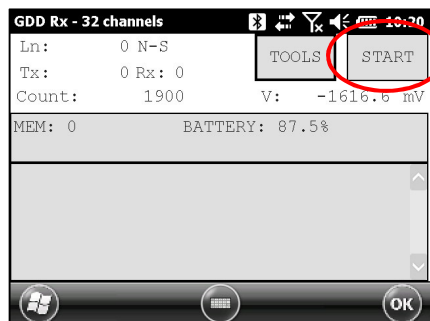

10. The following screen appears. Click OK to continue.



11. Enter the project, line, station, move displacement, etc. for Tx and Rx. Click OK to continue.

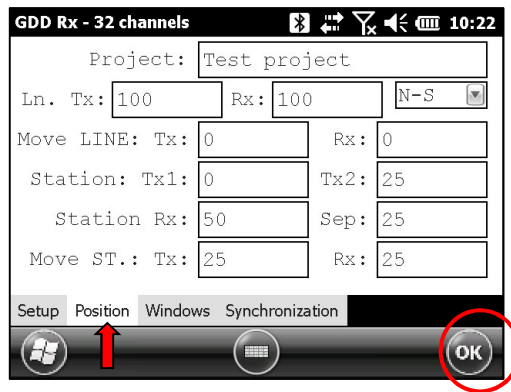

12. Verify if the positions are correct and click OK or press Enter keystroke to continue.

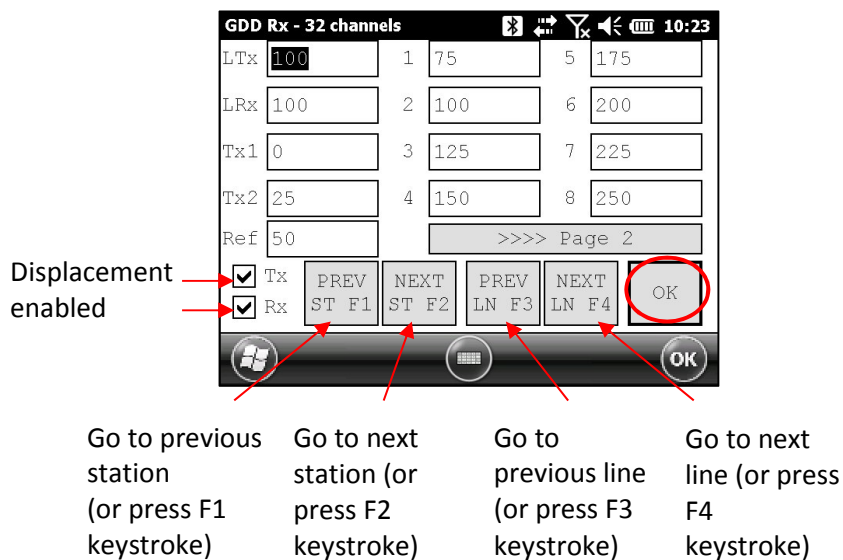

- The Contact and Noise graph appears. If the values displayed are normal, click OK or press ESC keystroke to close the window.

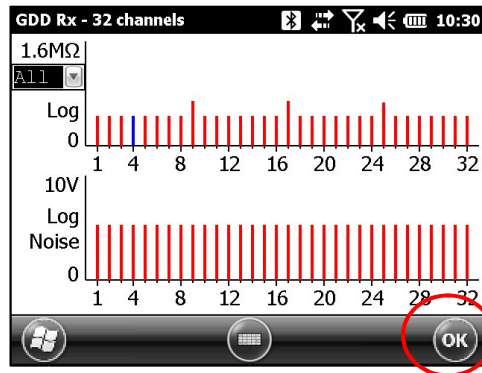

- Click NEXT or press Enter keystroke to continue.

*Note: If all stations show an INFINITE contact, the reference electrode might be disconnected.

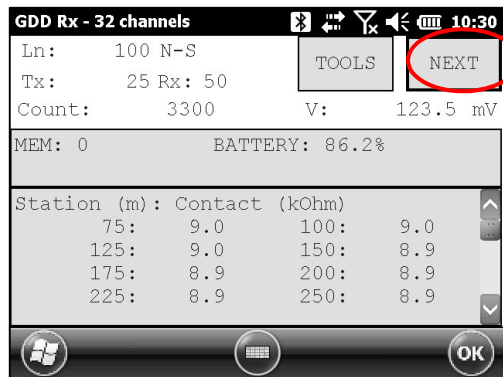

- Enter the transmitter current and click CONFIRM or press Enter keystroke to start the readings.

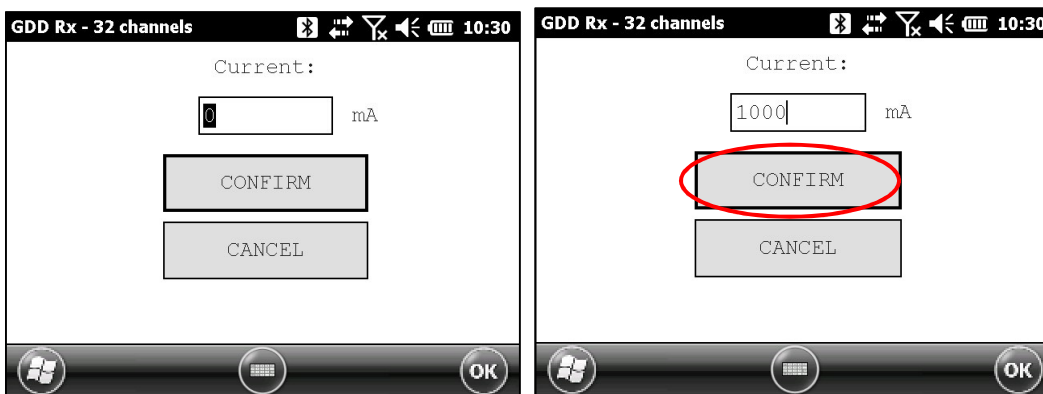

16. The following screens appear.

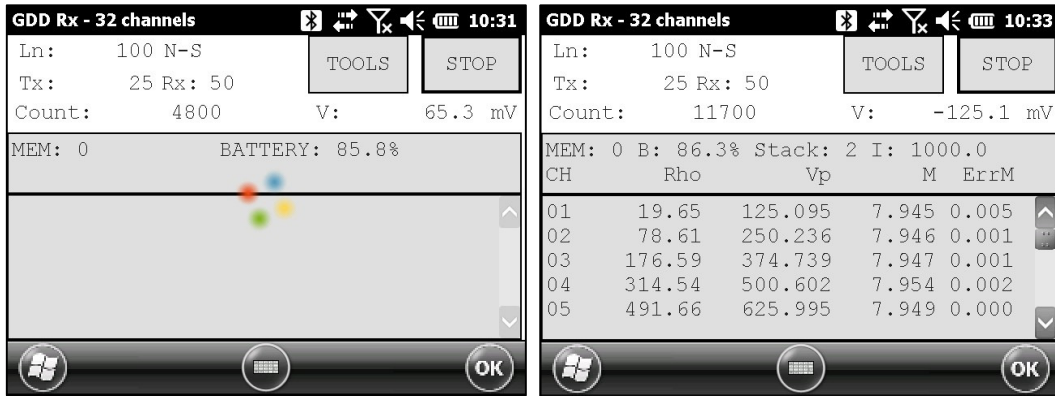

If using the optional GDD-RTE01 communication box (refer to section 8.2.5) to collect live information broadcasted by the GDD Tx4 IP transmitter, the Tx current "I" and power "P" can be displayed alternatively in the Rx main screen under the TOOLS and STOP/START buttons. To switch from one information to the other, use the following shortcut Key: "V" or click on the text label directly on the screen.

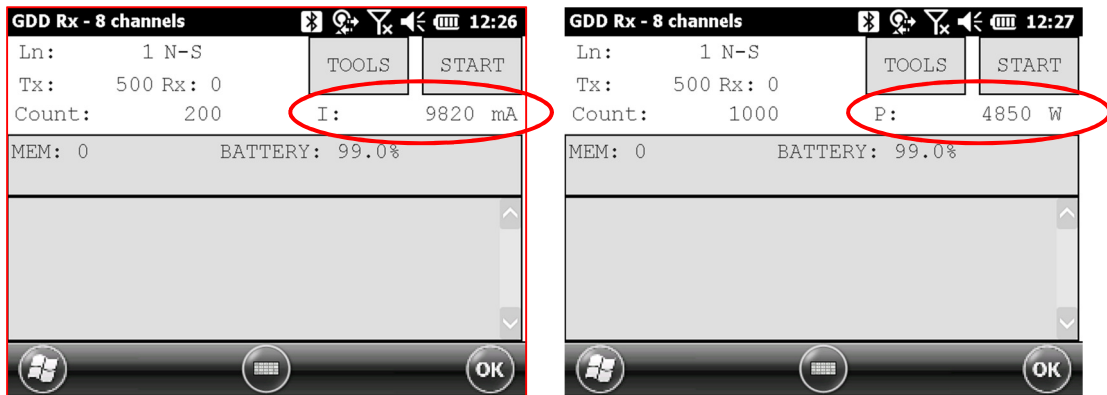

If no transmitter information can be received at the GRx8-32, the following symbol will be displayed instead of I and P: N/A.

17. Click STOP or wait until the end of the acquisition to stop the readings and save the data.

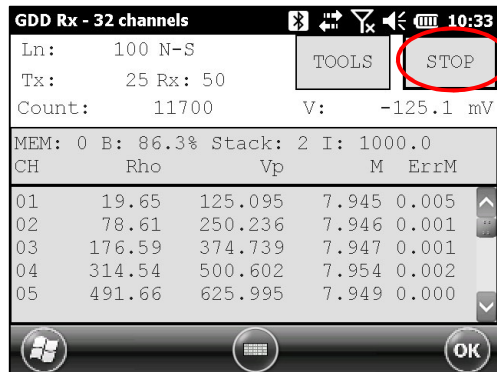

18. Click YES to confirm the operation.

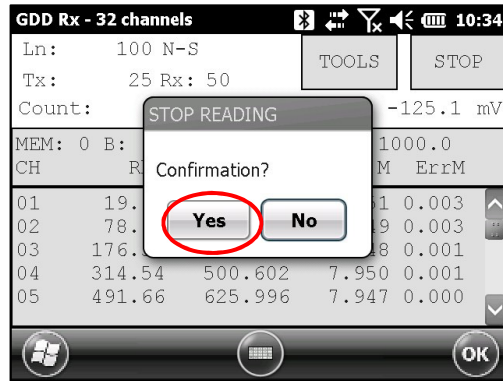

19. Click YES to save readings into the memory.

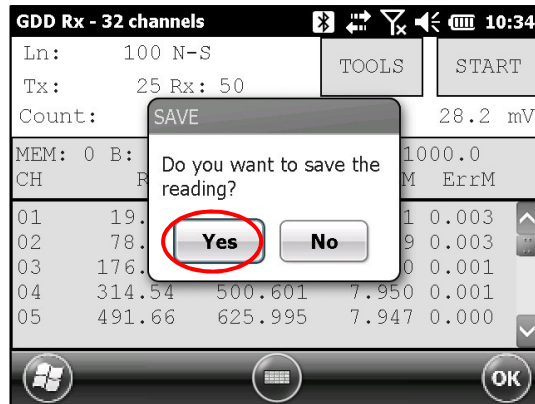

20. Re-enter the transmitter's output current value if it has changed and click CONFIRM to save the current value.

If using the optional GDD-RTE01 communication box (refer to section 8.2.5) to collect live information broadcasted by the GDD Tx4 IP transmitter, this menu will show additional Tx current options to choose as the final "I" value. These are the first "I" transmitted, the average "AI" (with information regarding Standard Deviation "SI" and average time between each Tx values broadcasted "AT") and the last "I" transmitted. Click on one of the corresponding button.

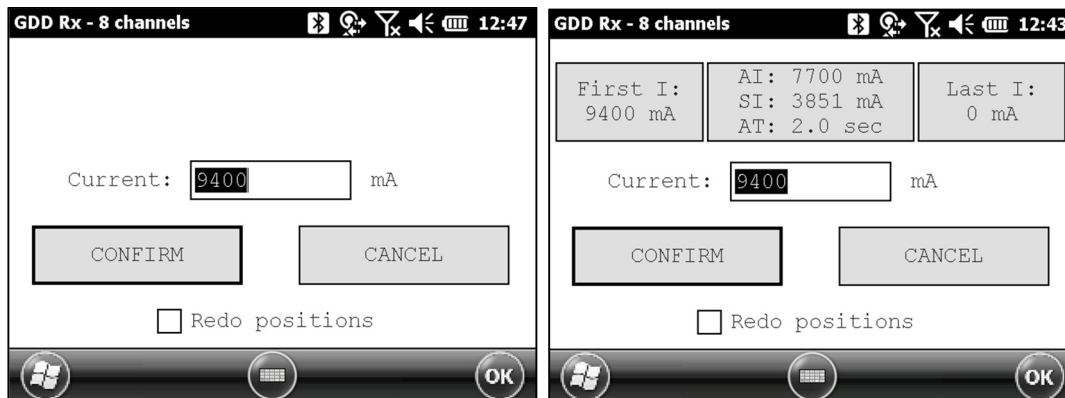

Check the REDO POSITIONS option to change the transmitter or receiver position.

Note: This option alters the reading that was just completed in order to correct or revise the coordinates before saving the reading to the file. It should not be used to pre-set the next reading.



If the REDO POSITIONS option is checked, enter the transmitter and receiver position and click OK or press Enter keystroke.

*Each position can be changed individually or moved by clicking Next or Prev (or by using F1 to F4 keystrokes).

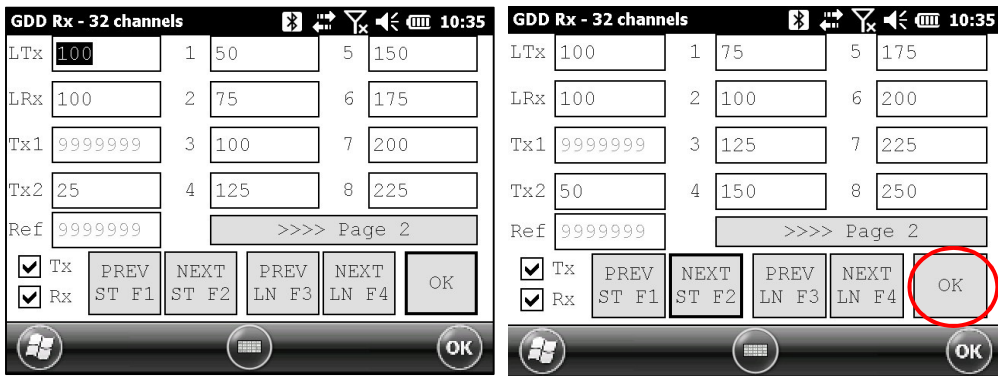

NOTE: Once your acquisition is completed, use Left and Right arrow buttons on the keypad of the Allegro² to compare your current data with that of your previous acquisitions. Use the Up and Down arrows to see all the channels. By clicking on Start, the program will automatically come back to the last acquisition and will start a new acquisition procedure.

GDD Rx - 32 channels

Ln: 100 N-S
Tx: 50 Rx: 75
Count: 25500 V: 2.9 mV

MEM: 2 B: 85.5% Stack: 2 I: 1000.0

CH	Rho	Vp	M	ErrM
01	19.65	125.091	7.955	0.008
02	78.61	250.233	7.946	0.001
03	176.62	374.788	7.949	0.002
04	314.54	500.598	7.947	0.002
05	491.65	625.980	7.947	0.001



GDD Rx - 32 channels

Ln: 100 N-S
Tx: 50 Rx: 75
Count: 25200 V: 103.5 mV

MEM: 3 B: 85.7% Stack: 5 I: 1000.0

CH	Rho	Vp	M	ErrM
01	15.72	100.066	3.929	0.011
02	62.89	200.176	3.926	0.005
03	141.27	299.772	3.928	0.004
04	251.60	400.423	3.925	0.005
05	393.35	500.819	3.926	0.002

21. Repeat steps 9 through 20 to take another set of readings.

6. RS232/Bluetooth Communication

1. Select the “RS-232” communication mode to use the GRx8-32 with a serial communication cable.

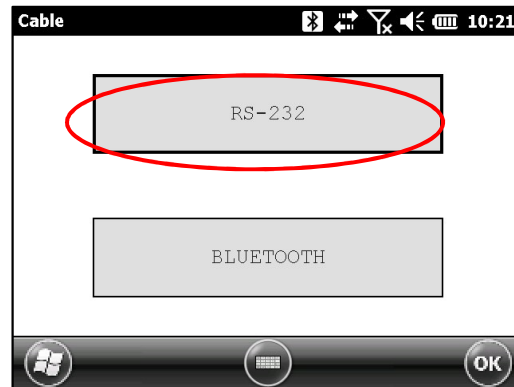

2. Select the “BLUETOOTH” communication mode to use the GRx8-32 with a wireless connection.



3. The following screen appears and you are ready to begin.

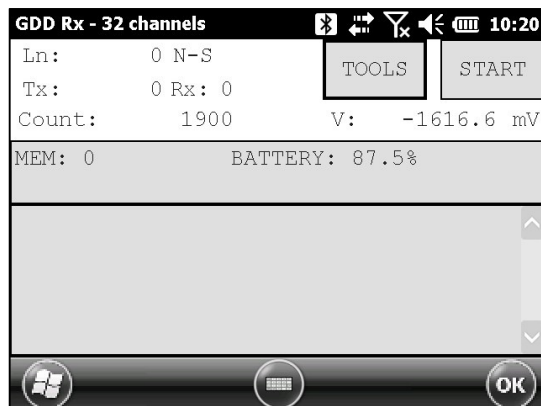

In Bluetooth mode, if a “COM Error” message appears, see *Section 12 – Troubleshooting*.

7. Cold weather and *harsh environments* tips

The GRx8-32 receiver is designed to be used in cold weather (up to -40°C) but it is very important to consider these few tips to prevent damages or malfunctions:

1. Never charge the internal batteries of the GRx8-32 in sub-zero;
2. As much as possible, turn on the GRx8-32 receiver in a warm place before using it in cold weather;
3. Never turn off the GRx8-32 receiver when using it in cold weather to keep the batteries warm;
4. If possible, use the serial communication (RS-232 cable) between the Allegro² and the GRx8-32 to prevent malfunction of the Bluetooth communication, and to maximize the battery charge.

When using the GRx8-32 receiver during rainy days, please consider the following tips to ensure a long term instrumental reliability:

1. The receiver's control panel, including each connector and input channel, is water resistant. Nevertheless, it is important to bring the receiver back at the base of operation after each day, to leave the pelican case lid open and to remove the connectors' cap so that humidity is freed from the instrument;
2. If possible while collecting data, close the lid of the pelican case to avoid water to soak the jack connectors and potentially short the channels;

8. Tools Menu

Click TOOLS to select one of the following options:

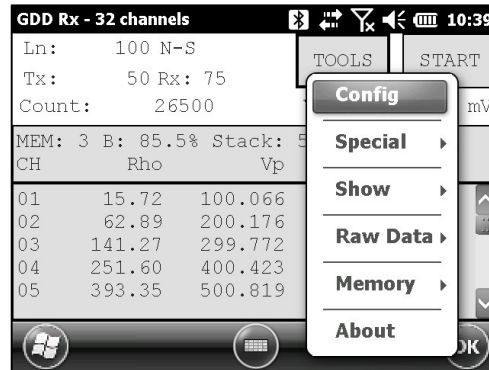

Config

Use the CONFIG option to change:

- Staking parameters
- Electrode array
- Active channel
- Trigger channel
- Line number and position
- Transmitter and receiver position
- Signal timing
- Mode
- GPS time synchronization

Special

Use the SPECIAL option to:

- Reinitialize the GRx8-32
- Test the GRx8-32 with the internal simulator
- Set signal processing options
- Select battery type (if not automatically detected)
- Open Port (enables the RF (radio frequency) communication between GDD's IP transmitter Tx4 and receiver using the optional GDD-RTE01 box.

Show

Use the SHOW option to display:

- Hotkeys (shortcut keys menu)
- PseudoSection
- Signal graph
- Contact and Noise monitor graph
- Vp and Cycle synchronization graph
- Decay curve
- Windows chargeability
- SP (self-potential)

Raw Data

Use Raw Data option to:

- Check GPS
- Start recording Binary Data File (.bdf)

Memory

Use the MEMORY option to:

- See the History
- Recall the previous memory
- Clear the memory
- Save data in a file

About

Use the ABOUT option to display the GDD Rx software version number.

8.1 Config option

8.1.1 Setup

The SETUP option is used to set the electrode arrays, the active channel(s) and the trigger channel.

1. Select Tools | Config | Setup. The following window appears.



2. Select the electrode arrays configuration.

- Dipole-Dipole (1/32)
- Dipole-Dipole (2/4)*
- Dipole-Dipole (2/16)
- Dipole-Dipole (4/8)
- Pole-Dipole (1/32)
- Pole-Dipole (2/4)*
- Pole-Dipole (2/16)
- Pole-Dipole (4/8)
- Pole-Pole (1/32)
- Pole-Pole (2/4)*
- Pole-Pole (2/16)
- Pole-Pole (4/8)
- Gradient (1/32)
- Gradient (2/4)*
- Gradient (2/16)
- Gradient (4/8)
- Wenner
- Schlumberger

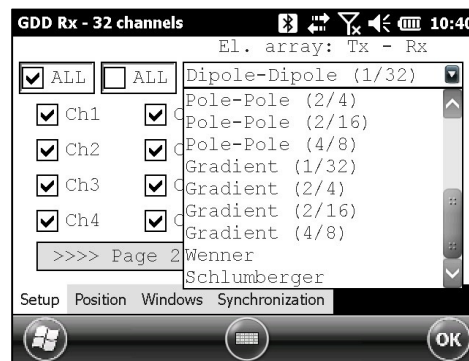
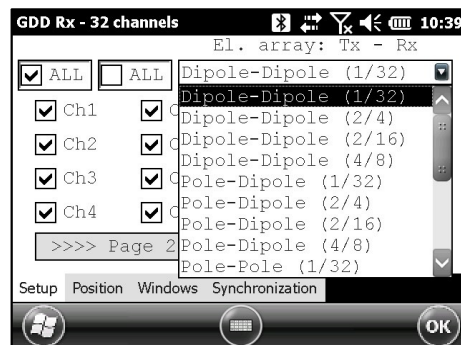

*For GRx8mini model only

3. Check the active channel(s). Tap on the ALL checkbox to select all channels, or tap on the ALL checkbox to unselect all channels.

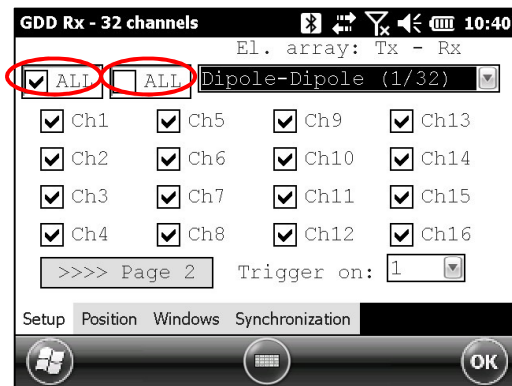

For a 32 channels receiver, channels 17-32 are shown on the second page. Click on the Page 2 button to see them.

4. Select the trigger channel, this channel is used for the synchronization process.

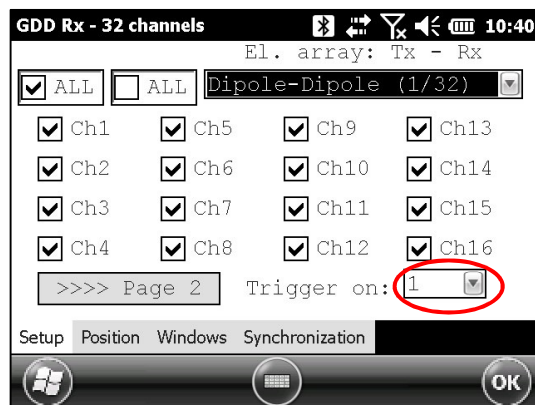

8.1.2 Position

The POSITION tab is used to set the following parameters: the Tx line number, the Rx line number, the line direction, the transmitter position (Tx1 and Tx2), the receiver position, the separation, the transmitter movement offset and the receiver movement offset.

1. Select Tools | Config | Position. The following screen appears.



2. Enter the line number and select the line's direction.

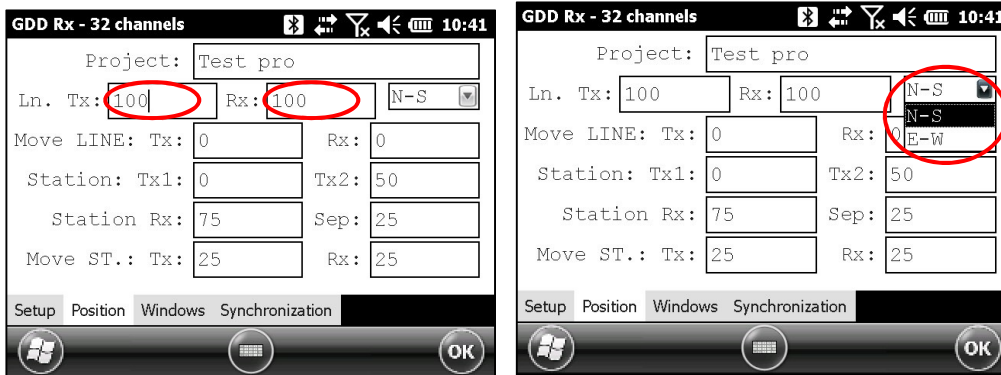

The labels N –S and E-W are used to define the direction of the lines.

3. Enter the first electrode position of the transmitter and receiver.

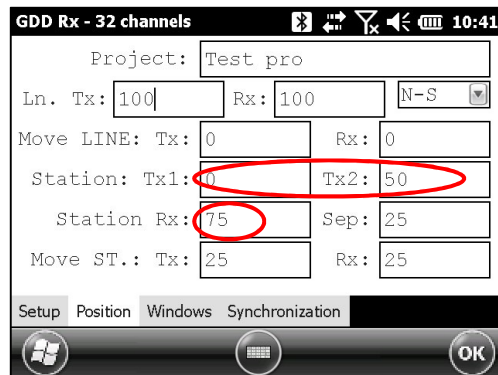

A negative number is used to define South and West.

4. Enter the separation between the electrodes of the receiver.

The screenshot shows the 'GDD Rx - 32 channels' setup screen. The 'Project' field is 'Test pro'. The 'Ln. Tx' field is '100' and the 'Rx' field is '100'. The 'Move LINE' section has 'Tx: 0' and 'Rx: 0'. The 'Station' section has 'Tx1: 0' and 'Tx2: 50'. The 'Station Rx' section has '75' and 'Sep: 25', where '25' is circled in red. The 'Move ST.' section has 'Tx: 25' and 'Rx: 25'. The bottom navigation bar includes 'Setup', 'Position', 'Windows', and 'Synchronization' tabs, and an 'OK' button.

A negative number is used to define South and West.

5. Enter the moving distance of the transmitter and receiver electrodes.

This screenshot is identical to the previous one, but with red circles highlighting the 'Tx' and 'Rx' fields in the 'Move LINE' and 'Move ST.' sections. In 'Move LINE', both 'Tx: 0' and 'Rx: 0' are circled. In 'Move ST.', both 'Tx: 25' and 'Rx: 25' are circled. The 'Sep: 25' field in the 'Station Rx' section is also circled in red.

A negative number is used to define South and West.

8.1.3 Windows

Use the WINDOWS option to set the signal timing and the mode.

1. Select Tools | Config | Windows. The following screen appears.



2. Select the maximum number of stacks.

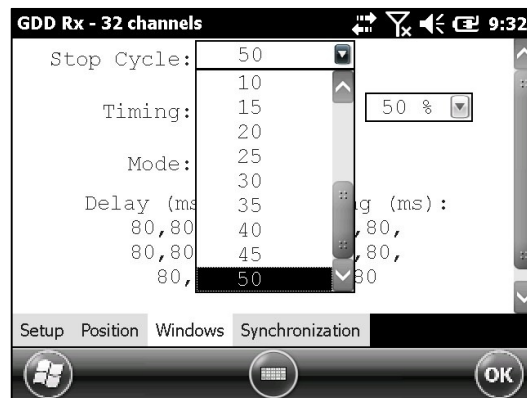

3. Select the signal timing.

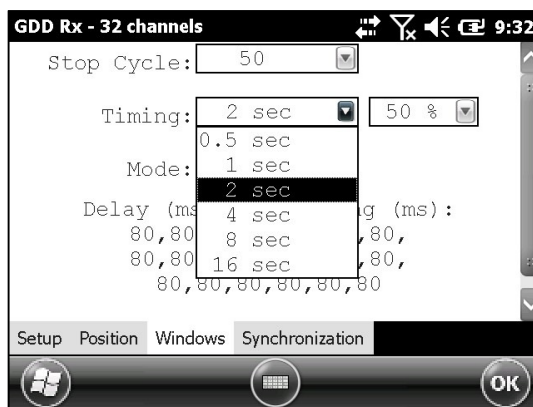

4. Select the Duty Cycle (50% or 100%).

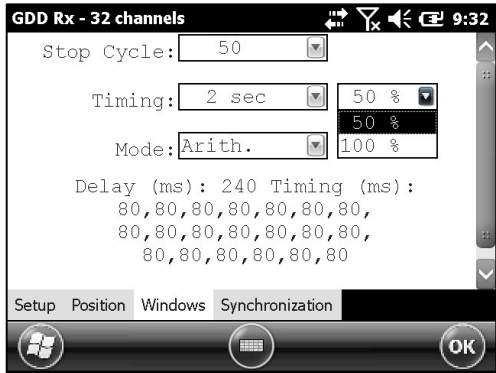

5. Select the mode (windows time definition).

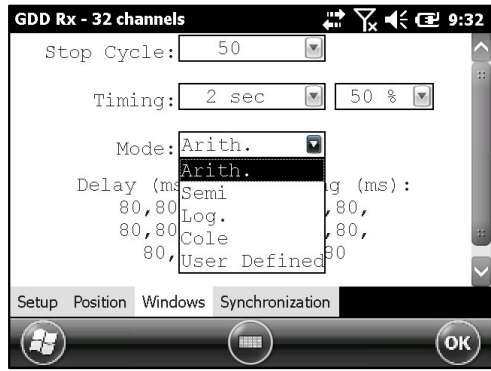

- Arithmetic

Windows: 20
Delay (ms): 240
Timing (ms): 2000
80, 80, 80, 80, 80, 80, 80, 80, 80, 80,
80, 80, 80, 80, 80, 80, 80, 80, 80, 80

- Semi logarithmic

Windows: 20
Delay (ms): 40
Timing (ms): 2000
40, 40, 40, 40, 40, 40, 80, 80, 80, 80,
80, 80, 80, 160, 160, 160, 160, 160, 160, 160

- Logarithmic

Windows: 4

Delay (ms): 160

Timing (ms): 2000
120, 220, 420, 820

- Cole

Windows: 20

Delay (ms): 20

Timing (ms): 2000

20, 30, 30, 30, 40, 40, 50, 60, 70, 80,
90, 100, 110, 120, 130, 140, 150, 160, 180, 200

- User defined

Windows: between 1 and 20

Delay (ms): user defined

Timing (ms): user defined

In USER mode, you can load settings you have previously saved, or you can create new settings.

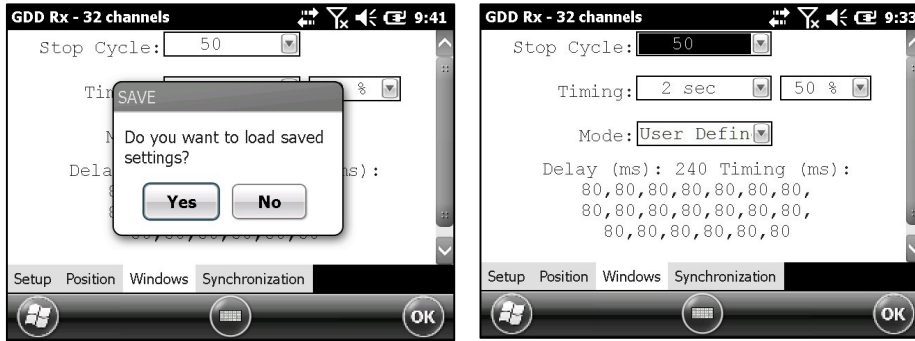

Click YES to load your settings from a previously saved file. This window will appear.

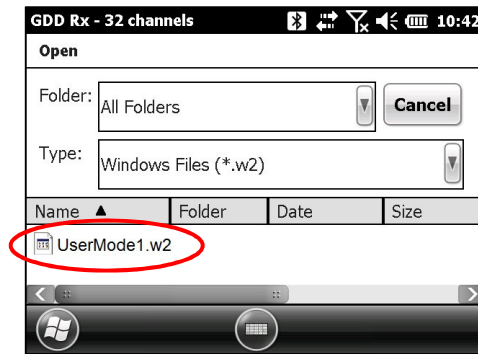

In this dialog box, select your file. The Windows window appears automatically. Click OK. The saved values will be loaded in the User defined mode.

OR

Click NO to manually enter the delay and window(s) width.

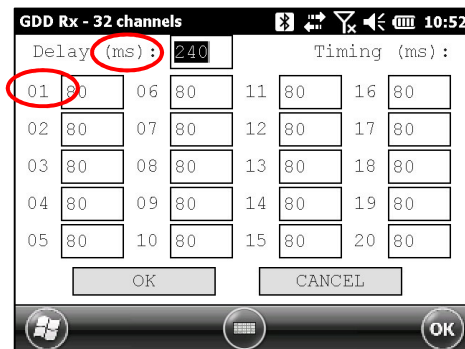

Click OK when your settings are configured.

Click YES to save your new settings.

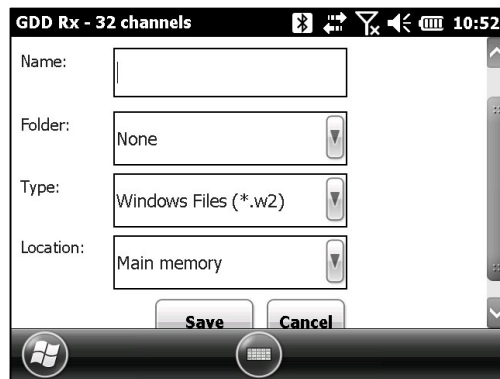
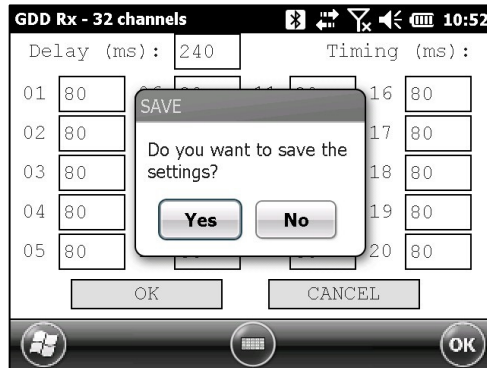

Enter your filename and the location where you want to save your file. Then click SAVE. The User defined settings will be saved so you can reload them into the Allegro² later.

OR

Click NO if you do not want to save your User defined settings to a file.

In all cases, you will be brought back to this display and the settings you have entered in the User defined window will be loaded into the Allegro².

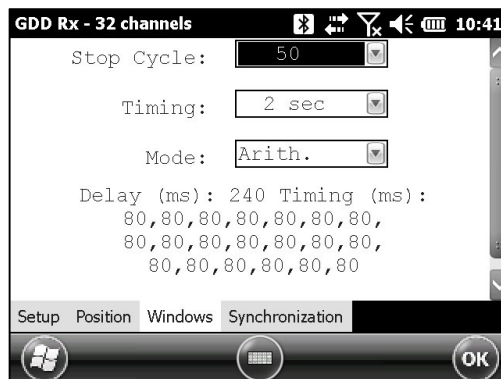

8.1.4 Synchronization

Use the GPS time synchronization if you need to synchronize your receiver to your transmitter using GPS time.

Requirements:

- Your receiver must be equipped with an internal GPS module.
- Your Allegro² must have the Rx software version # 4.2.39 or higher and your receiver must have Rx firmware # 0.2.5.9 (or newer versions).
- Your transmitter (itself or linked to another unit) must be synchronized with a GPS.

1. Refer to *Section 8.4* to verify if a satellite is being tracked by the GPS module of your receiver.
2. Select Tools | Config | Synchronization. The following screen appears.

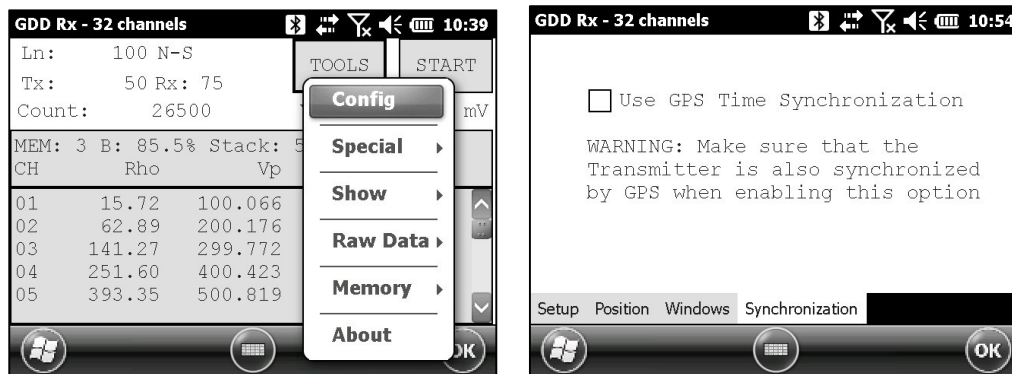

3. Check *Use GPS Time Synchronization* to enable the GPS synchronization.

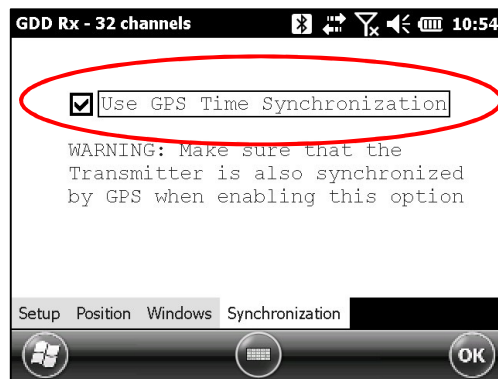

IMPORTANT: Make sure that your transmitter is also synchronized by GPS before using this option.

Note that the GPS synchronization is disabled every time you start the program even if you checked it the last time you used it.

4. Before starting your acquisition process, make sure your transmitter and your receiver are well synchronized:
 - **Wait for about 15 minutes before taking your first reading to ensure that the GPS module of the receiver gets the real UTC GPS time.**
 - If possible, compare the GPS time of your transmitter with the GPS time of your receiver. They must have exactly the same GPS time (see *Section 8.4* to know how to get the GPS time of the receiver).

5. During the acquisition process, you can verify if your receiver is still synchronized with GPS (see *Section 8.4* to know how to verify the GPS signal):

GPS well synchronized

If you checked *Use GPS Time synchronization* and if a GPS signal is detected, your receiver will be synchronized with GPS.

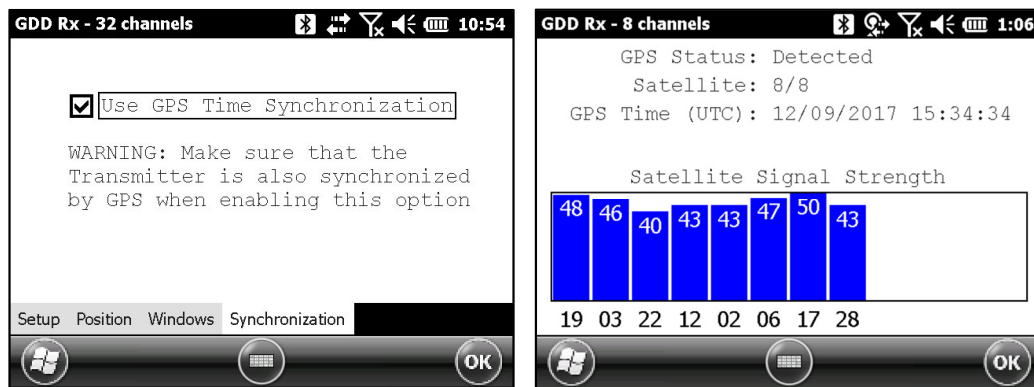

IMPORTANT: it does not confirm that your receiver is well synchronized with your transmitter. In the case that your transmitter and your receiver are not well synchronized together, your data could be erroneous.

GPS signal lost for less than 5 hours

If you checked *Use GPS Time synchronization* and if the GPS signal is lost for less than 5 hours, your receiver will still be synchronized with GPS using the internal GPS clock.

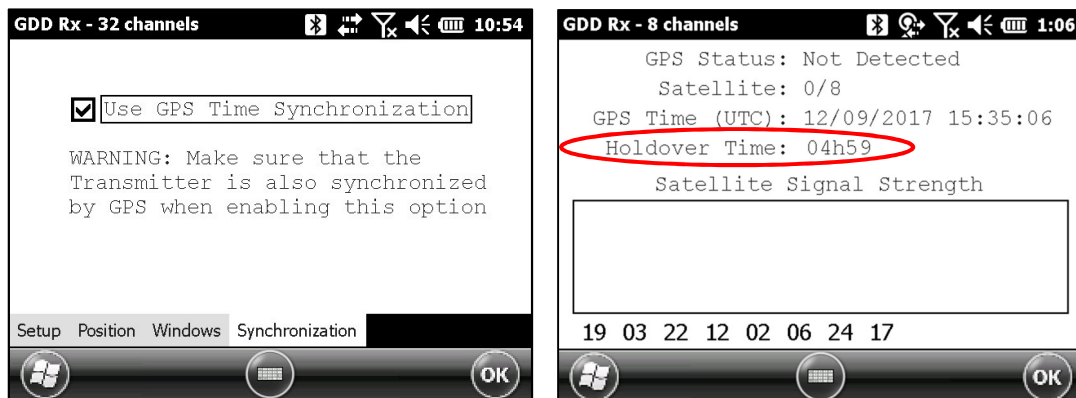

No GPS signal from the beginning, GPS signal lost for more than 5 hours or Use GPS Time synchronization unchecked

If you checked Use GPS Time synchronization and if there is no GPS signal or if it is lost for more than 5 hours, the receiver will automatically switch to synchronize with the ground signal.

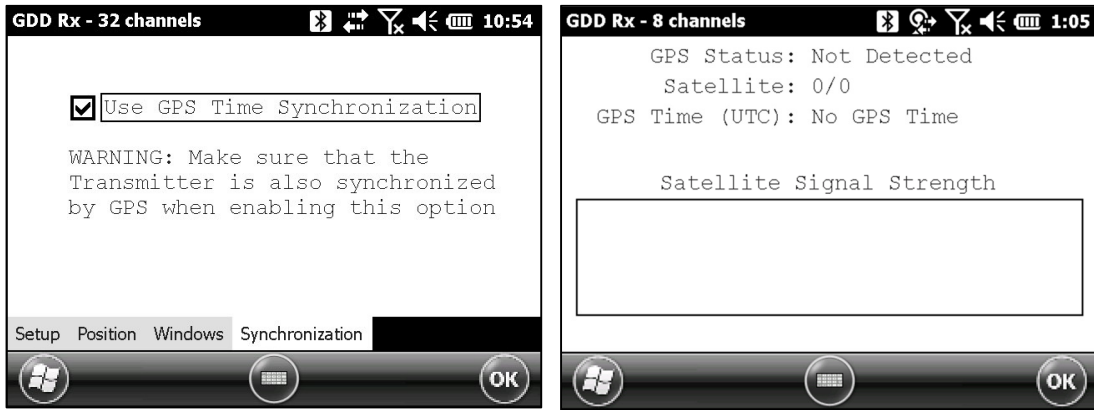

Note that the data acquired with the GPS synchronization can be more accurate than those acquired with the ground signal, especially over noisy environment.

IMPORTANT: During the acquisition process, if all your Vp values are negative, you can switch the polarity of the current transmission at the transmitter (switch the wires at the HV block) and all de Vp will become positive.

- 6. The .gps output file indicates if the receiver is synchronized with signal or GPS (see Section 8.5 to know how to create a .gps file).

```
Version PPC: 0.4.2.39 Version RX: 8.1.0.0 RX SN: 1266
Project: Project
windows: 20 Setting: User Delay (ms): 240 Timing (ms): 80, 80, 80, 80, 80, 80, 80, 80, 80, 80, 80, 80, 80, 80, 80, 80, 80, 80, 80, 80
Mem Date Hour GPS SyncBy Array LineTx LineRx Dir n Tx1 Tx2 Rx1
1 27/08/2015 19:25:25.753399 YES SIGNAL DP-DP 100.00 100.00 N-S 1.0 0.00 50.00 75.00
1 27/08/2015 19:25:25.753399 YES SIGNAL DP-DP 100.00 100.00 N-S 2.0 0.00 50.00 100.00
2 27/08/2015 19:29:44.062906 YES GPS P-P 100.00 100.00 N-S 0.0 9999999.00 50.00 75.00
2 27/08/2015 19:29:44.062906 YES GPS P-P 100.00 100.00 N-S 0.0 9999999.00 50.00 100.00
```

The SyncBy column indicates SIGNAL if the receiver is synchronized with the signal connected to the trigger channel and GPS if the receiver is synchronized with the GPS time.

IMPORTANT: Even if the file indicates that your receiver is synchronized with the GPS time, it does not confirm that your receiver is well synchronized with your transmitter. In the case that your transmitter and your receiver are not well synchronized together, your data could be erroneous.

8.2 Special option

8.2.1 Reinit

The REINIT option is used to reset GRx8-32 configurations and communication with the Allegro².

1. Select Tools | Special | Reinit



2. Click YES to reinitialize the GRx8-32.

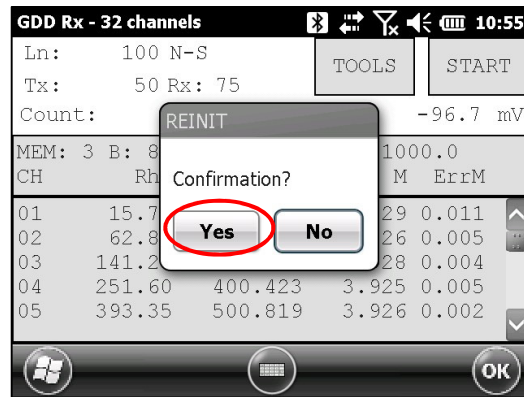

***** WARNING *****

Please ensure your MEM number is the same than before having reinitialized your GRx8-32. If MEM displays a 0 value, you may need to exit the GDD_Rx software, wait 15 seconds and start the application again. The MEM should be back to its original count. This issue happens when the PDA does not detect the memory card.

8.2.2 Simulation

The SIMULATION option is used to perform a self-test with the internal waveform generator (you need to select the Pole-Pole configuration to use this option).

1. Select the SELF-TEST mode using the ON/OFF/SELF-TEST switch.

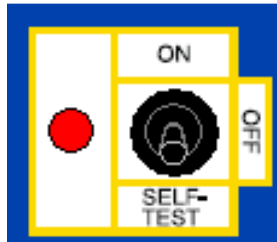

2. Short the SELF-TEST terminal with the channel(s) you want to test. The picture below shows a self-test testing the first eight channels.

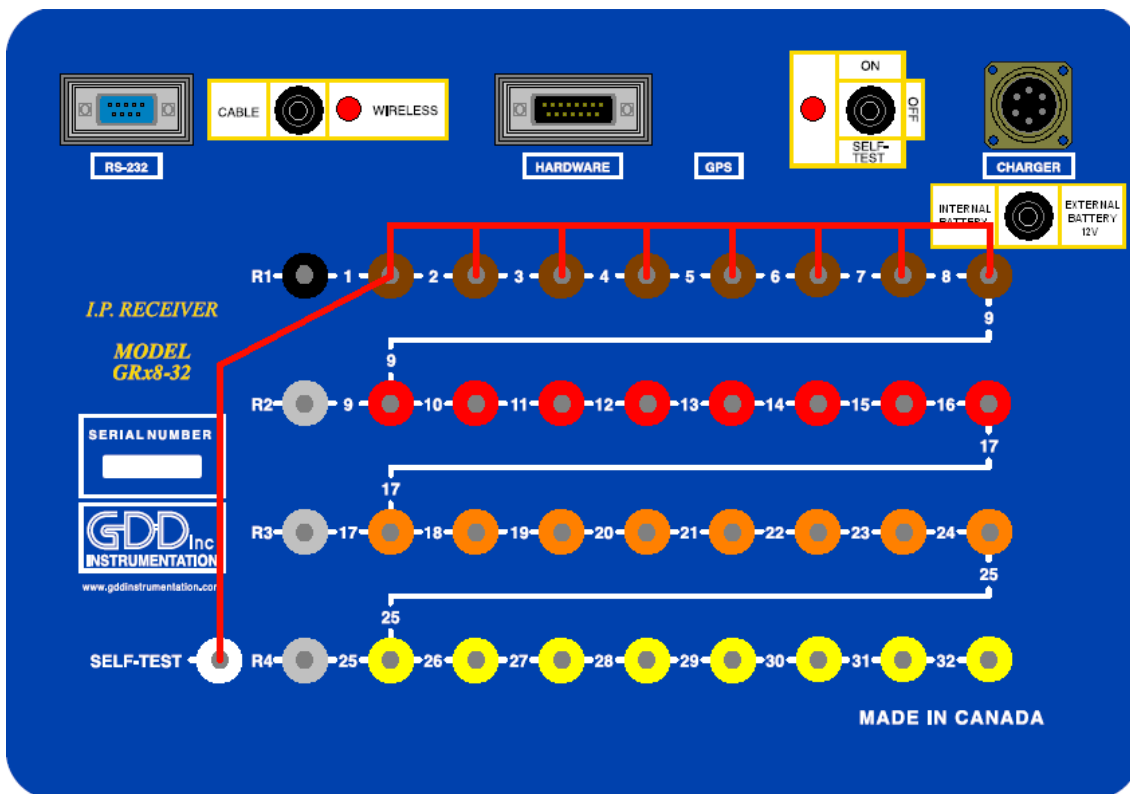

3. Select Tools | Config | Setup

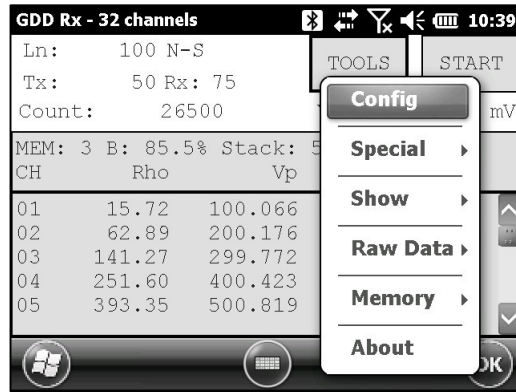

4. The following screens appear.



5. Select the Pole-Pole (1/32) array configuration.

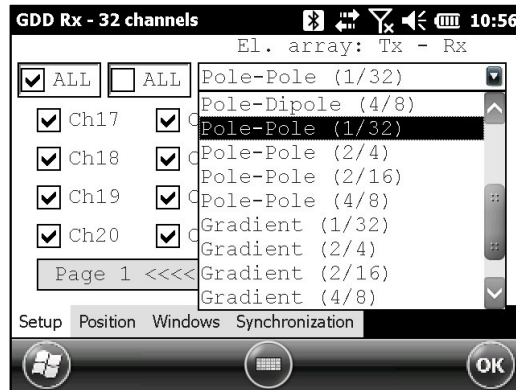

6. Check the channel(s) you want to test.

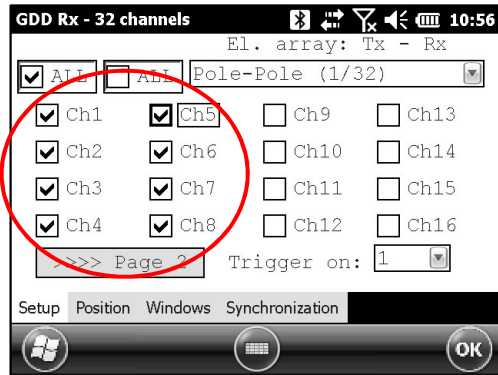

7. Select Tools | Special | Simulation



8. Enter the waveform timing (default = 2000ms).
9. Enter the primary voltage (default = 500mV).
10. Enter the chargeability (default = 0).

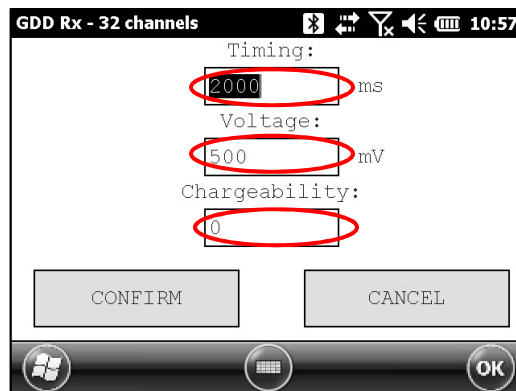

11. Click CONFIRM.

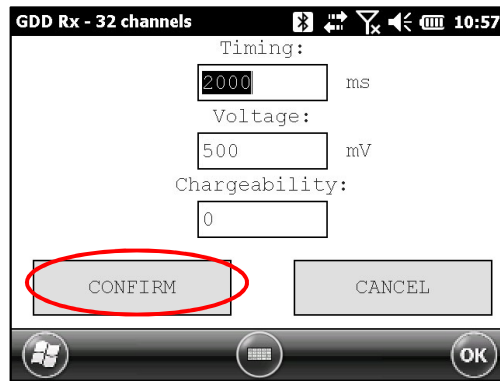

12. Click START to begin the acquisition process.

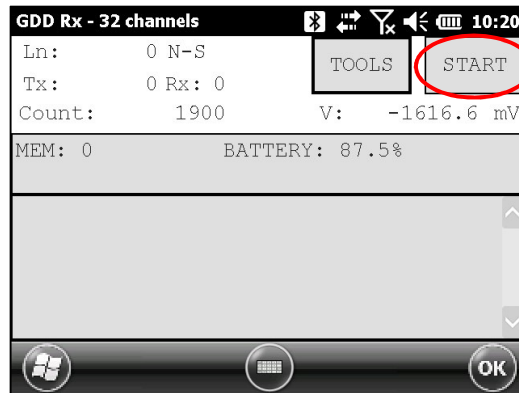

If you keep the default settings you should obtain the following results for all channels:

$V_p \approx 500\text{mV}$ $M \approx 0.000$

When you enter a VP of 500 mV in the self-test simulation mode, it is possible that the actual voltage generated is 504, 505, 506 mV, etc. It does not mean that the channels are not working properly. It would be a problem if the VP value is not the same during a reading for every channel. For example, a value of 520mV for one channel while you get a value of 503mV for the other ones.

8.2.3 Signal Processing Options

The SIGNAL PROCESSING OPTIONS are used to disable the default gain and offset settings. When offset and gains are applied, the signal to noise ratio is improved.

1. Select TOOLS | Special | Signal Processing Options



2. Check the checkboxes of the settings you want to disable and click CONFIRM.

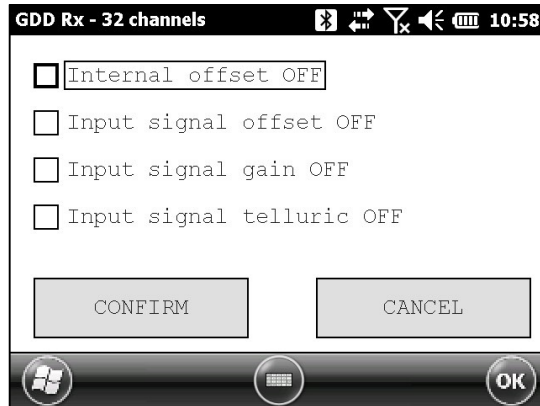

Note that the gains and offsets are enabled (applied) every time you start the GDD Rx program again even if you disabled them the last time you used them.

8.2.4 Battery type

With Rx firmware version 2.5.4 or higher, the GDD Rx program detects the type of batteries in the receiver automatically.

If a battery type is detected, the information will appear in the About pop-up window.

Select Tools | About

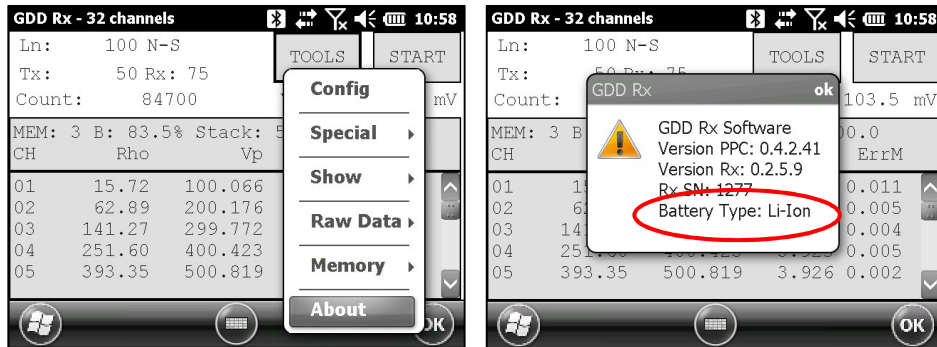

If the GDD Rx program cannot detect the battery type (older Rx firmware versions), the About pop-up window will indicate *Battery Type : not detected*.

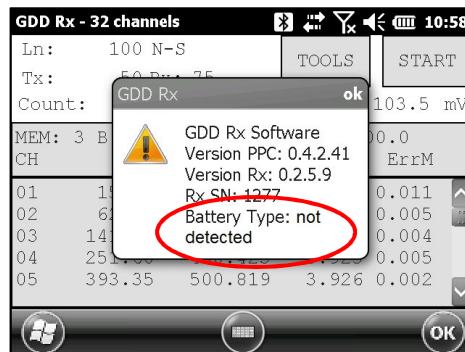

In which case, it is possible to select the battery type manually.

Select Tools | Special | Battery Type

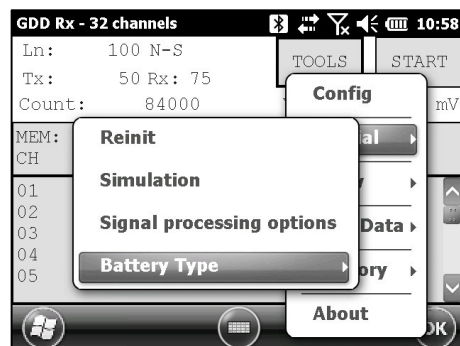

Select the type of batteries in your receiver.

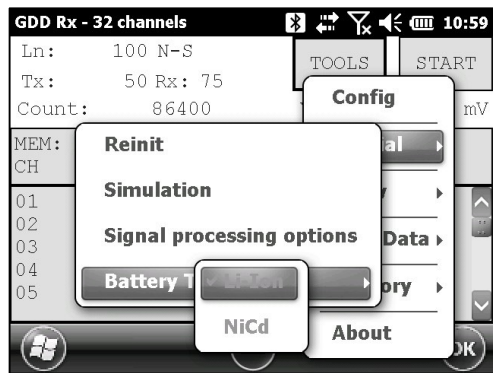

Refer to your receiver's charger to find out which type of batteries your receiver has.

Ni-CD batteries



Li-Ion batteries



If you select the wrong battery type, the battery level indicated in the main window of the GDD Rx program will be slightly different from the actual value.

8.2.5 Open Port

The OPEN PORT option is used to enable the Tx-Rx RF communication when using the optional GDD-RTE01 box.

1. Connect the optional GDD-RTE01 box to the USB port of your Allegro²
2. Select Tools | Special | Open Port

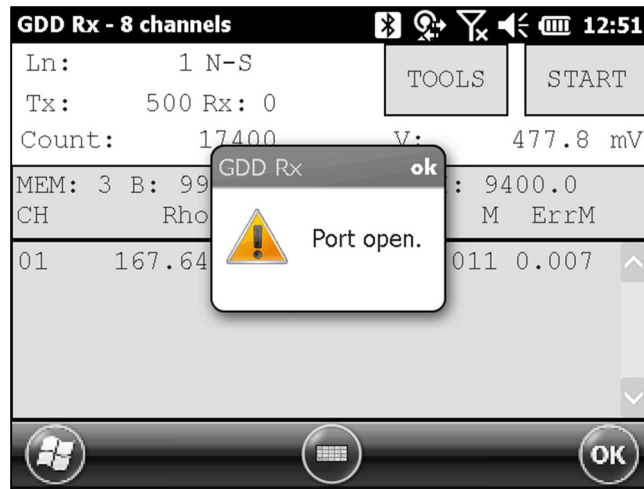

If the GDD-RTE01 box is not connected or defective, the following message will pop up.

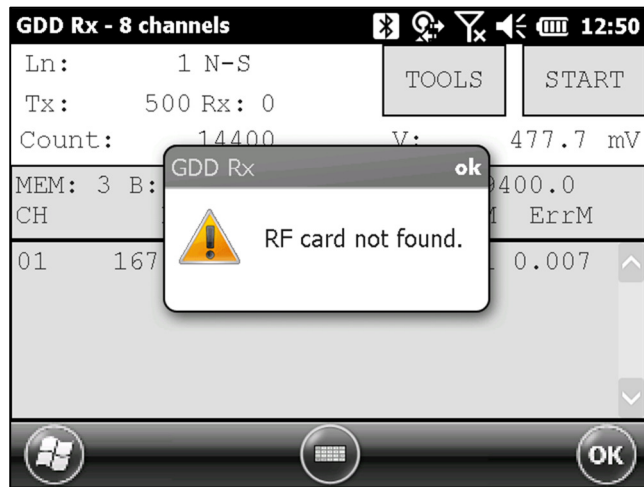

8.3 Show option

8.3.1 Hotkeys

The HOTKEYS option is used to display the shortcut keys menu.

1. Select Tools | Show | Hotkeys
Hotkey 'M'



2. The following screen appears.

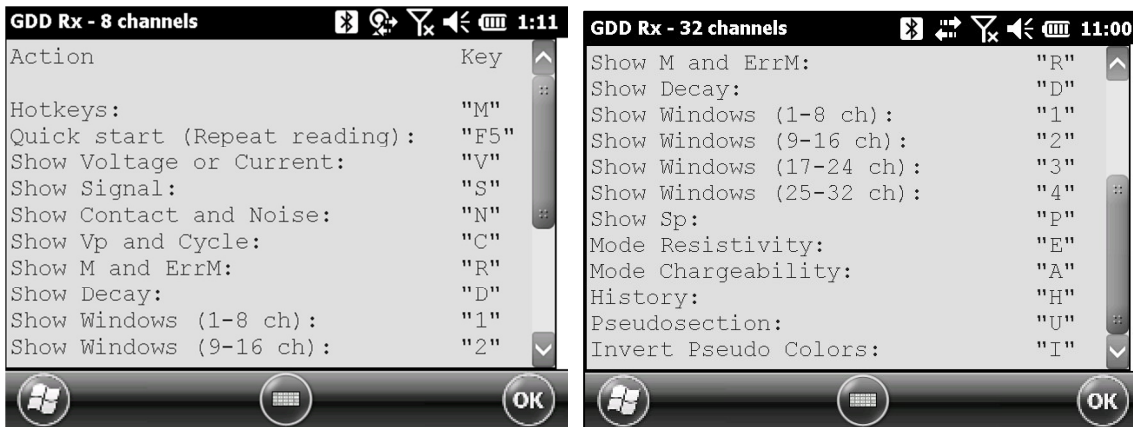

Use the shortcut keys to navigate quickly between the different options. The Quick Start option (F5) can be used to start the acquisition procedure using the same settings as the previous acquisition. Using F5 will skip the settings and contact resistance windows.

8.3.2 Pseudosection

The Pseudosection option is used to display the calculated pseudosection (in color) for each surveyed line.

1. Select Tools | Show | Show Pseudosection
Hotkey 'U'



2. The following screen appears.

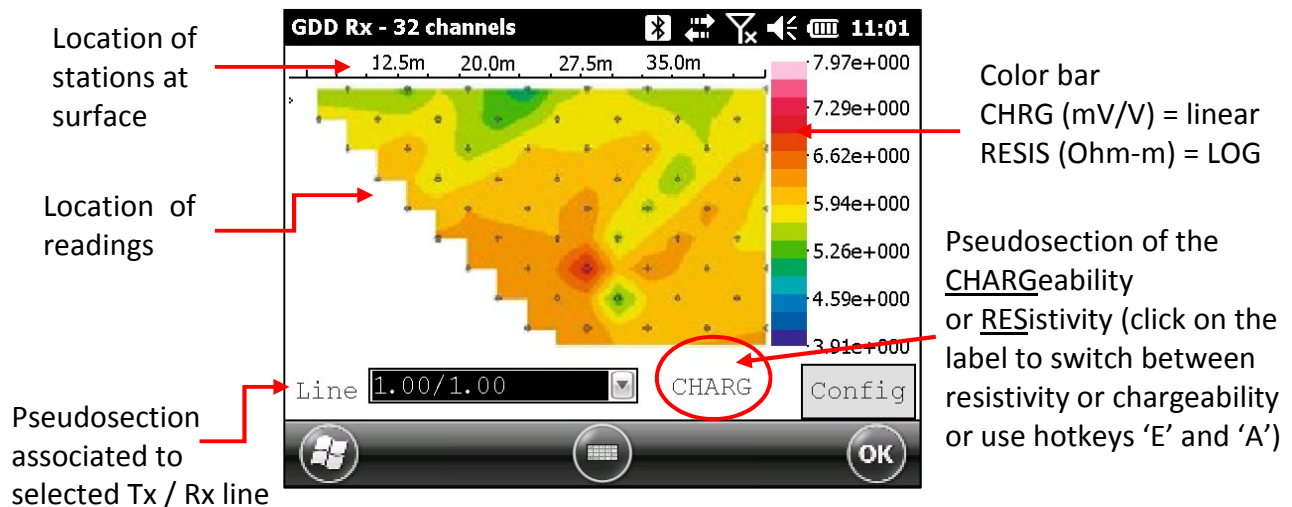

Note: Use the hotkey 'I' to invert the Pseudo colors.

3. Color bar editing.

Click on the "Config" button in the pseudosection main screen.

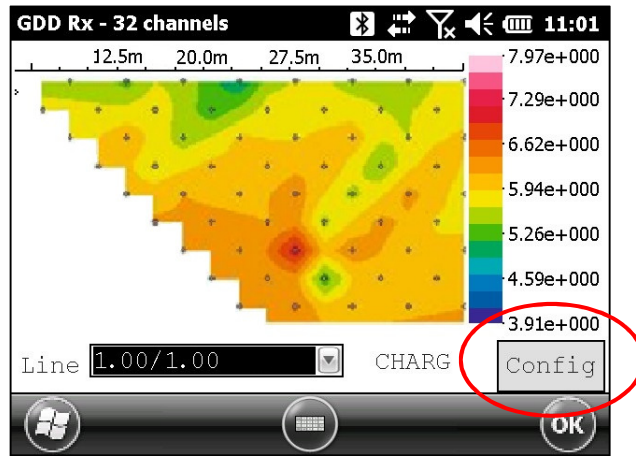

The following screen appears.

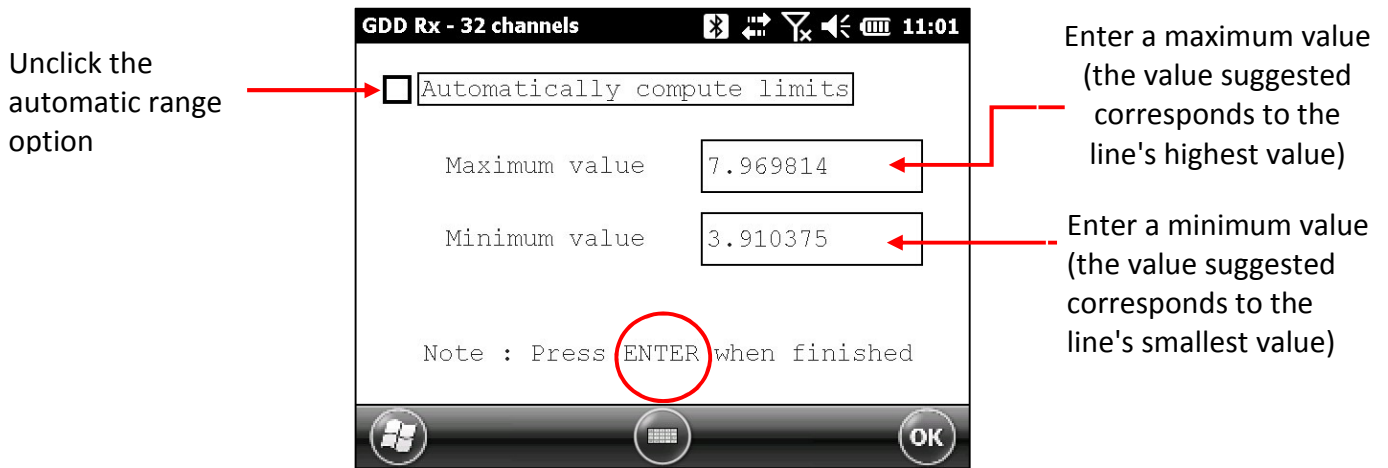

To validate and go back to the pseudosections view, you can either click on « Enter » or on the « OK » button.

4. To visualize the whole pseudosection, use the arrows on the PDA keyboard:

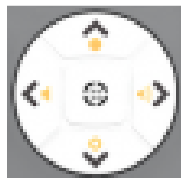

8.3.3 Signal

The SIGNAL option is used to display the signal graph of a selected channel.

1. Select Tools | Show | Show Signal
Hotkey 'S'



2. The following screen appears.

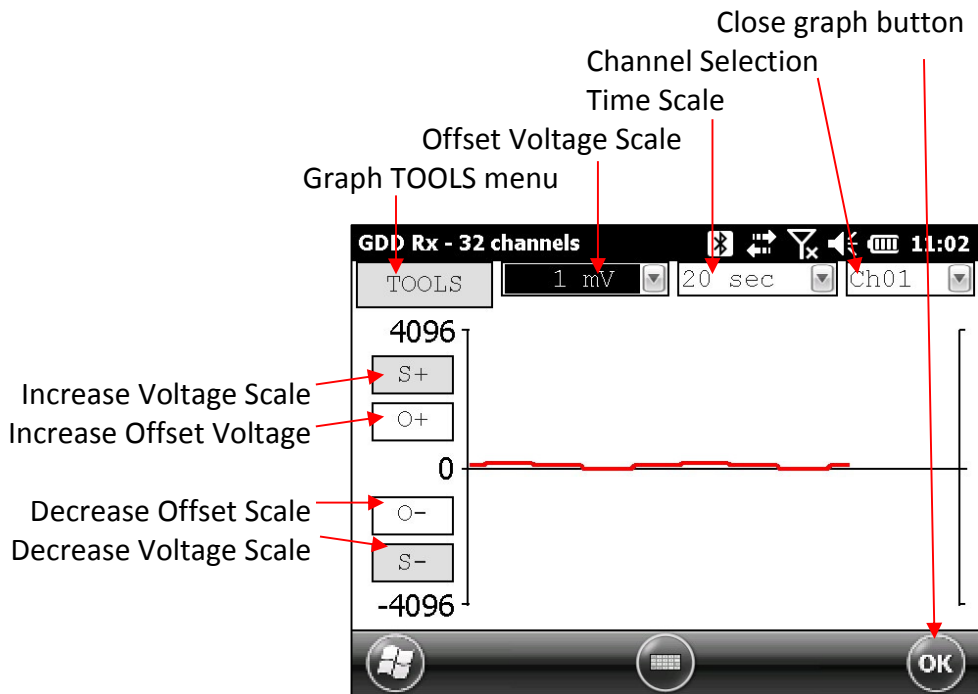

3. Select offset voltage scale.

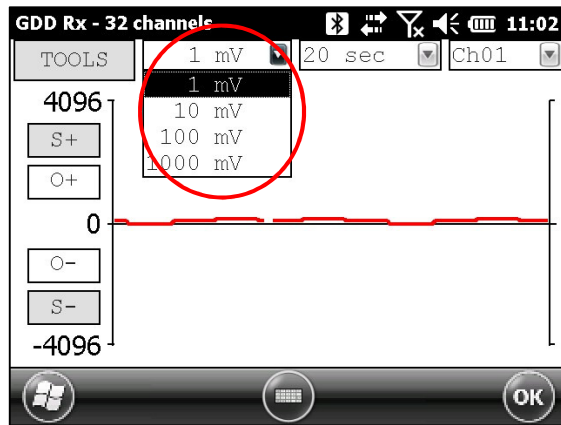

4. Select time scale.

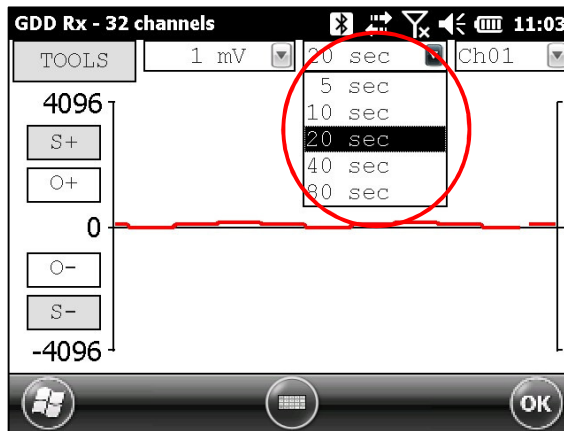

5. Select display channel.

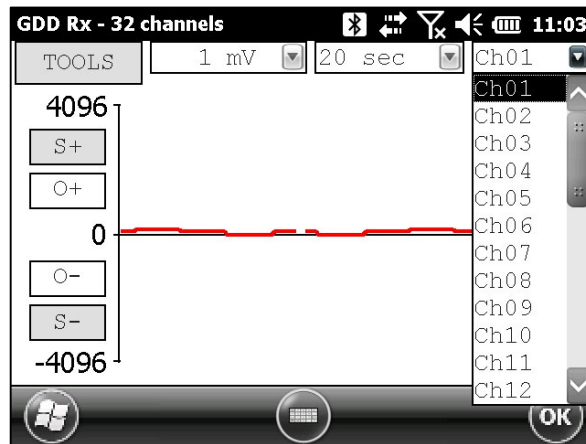

8.3.3.1 Tools menu

8.3.3.1.1 Auto Correction

The AUTO CORRECTION option is used to optimize the graph scale and correct the offset of the signal. This option should be used after one signal period (8 sec for a 2 sec time base).

1. Select Tools | Auto Correction

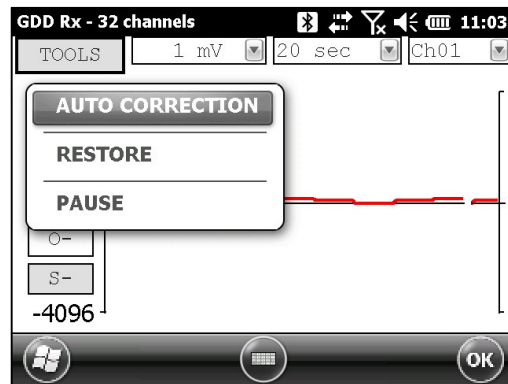

8.3.3.1.2 Restore

The RESTORE option is used to reset the settings to default.

1. Select Tools | Restore

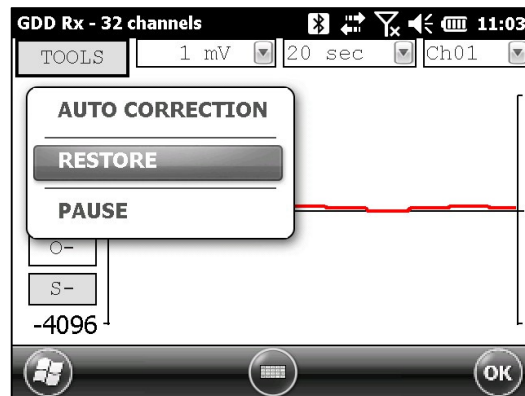

8.3.3.1.3 PAUSE/GO

The PAUSE/GO option is used to pause or play the signal.

1. Select Tools | Pause or Tools | Go

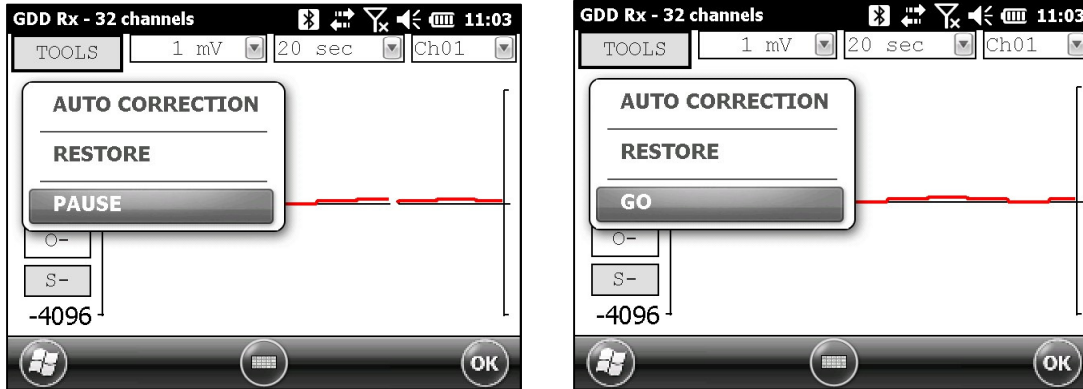

8.3.4 Contact and Noise

The CONTACT AND NOISE option is used to display the noise graph of all of the channels. This option can be useful for troubleshooting if you have a noise problem. The Contact graph shows the contact resistance between the electrodes and the ground.

*This option should be used before your transmitter sends a current. If the transmitter sends a current, the Vp signal will be displayed for each active channel.

1. Select Tools | Show | Show Noise
Hotkey 'N'



2. The following screen appears.

Transmitter is *not* sending a current

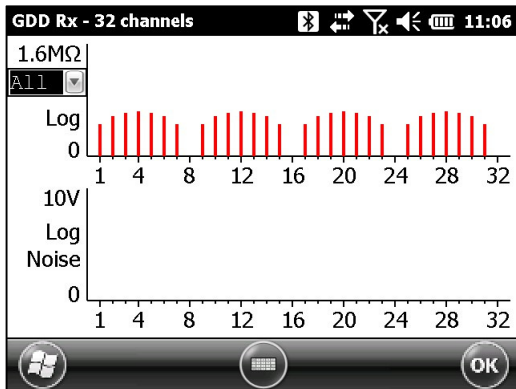

Transmitter is sending a current.

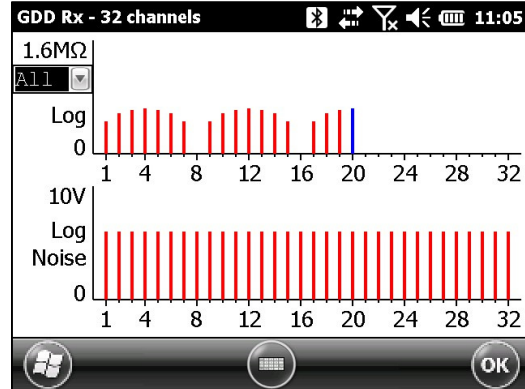

8.3.5 Vp and Cycle

Steps 14 to 16 of *Section 5* of this Manual must be done before using this feature.

The VP AND CYCLE option is used to show the channel synchronization. This option can be useful for troubleshooting if you have any connection problems. The VP part of the graph shows the primary voltage of all your electrodes. The current graph is an example; your VP graph will depend on the physical configuration of the electrodes.

1. Select Tools | Show | Show Cycle
Hotkey 'C'

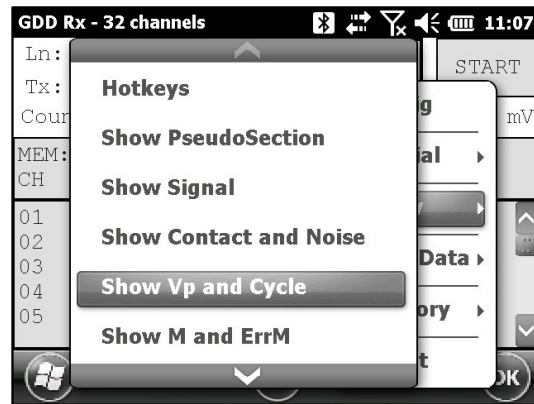
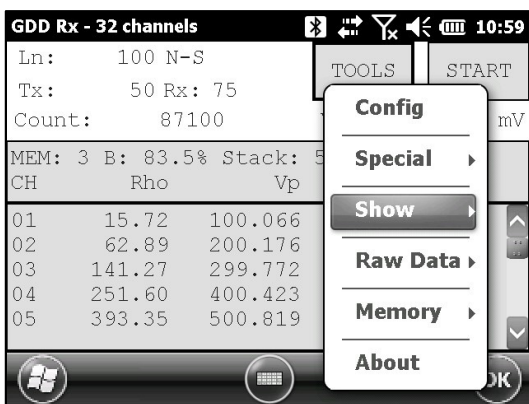

2. The following screen appears.

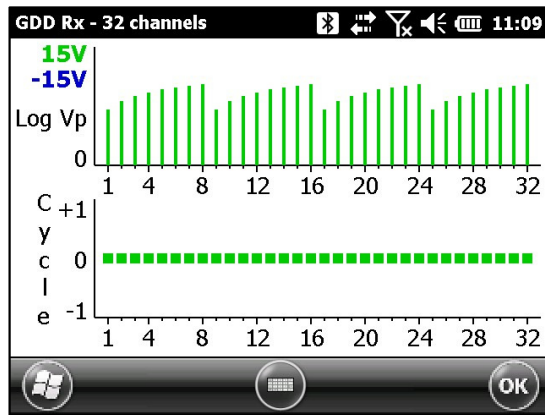

- Green line indicates that this Vp is positive.
- Blue line indicates that this Vp is negative.
- Red dots indicate that the GRx8-32 is not synchronized.
- Green dots indicate that the GRx8-32 is synchronized.
- If the GRx8-32 is synchronized and the green dots are not moving in the same direction, check the position of the electrodes on the GRx8-32 front panel.

8.3.6 Show M and errM

Steps 14 to 16 of *Section 5* of this Manual must be done before using this feature.

The Show M and errM option is used to display the chargeability and the error in chargeability for each channel.

1. Select Tools | Show | M and errM
Hotkey 'R'



2. The following screen appears.

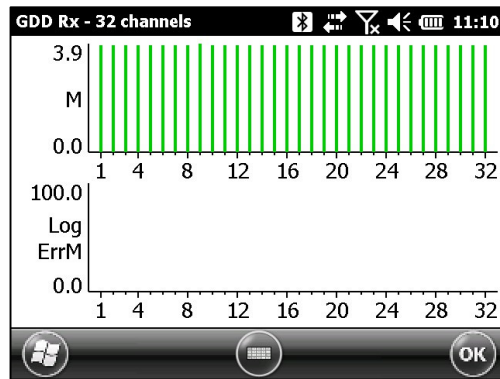

8.3.7 Decay Curve

Steps 14 to 16 of *Section 5* of this Manual must be done before using this feature.

The *Decay Curve* option is used to display the decay graph of a selected channel.

1. Select Tools | Show | Show Decay
Hotkey 'D'

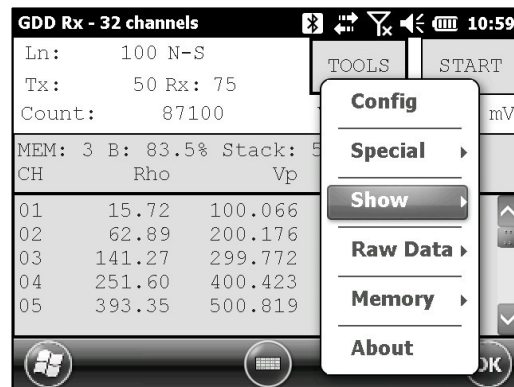

2. The following screen appears.

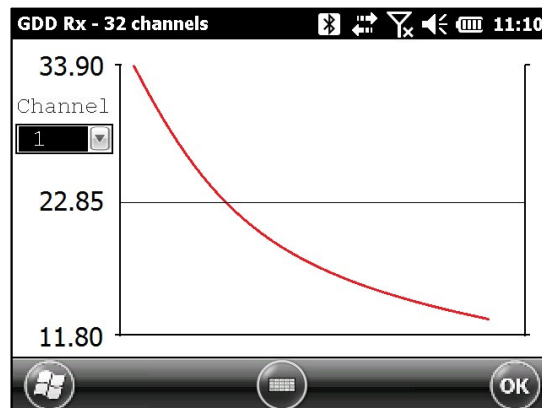

3. Select the display channel.



8.3.8 Show Windows

Steps 14 to 16 of *Section 5* of this Manual must be done before using this feature.

The *Show Windows* option is used to display the chargeability windows of each channel.

1. Select Tools | Show | Show Windows (1-8 ch), (9-16 ch), (17-24 ch) or (25-32 ch)
Hotkeys '1' (1-8 ch), '2' (9-16 ch), '3' (17-24 ch), '4' (25-32 ch)



2. The following screen appears.

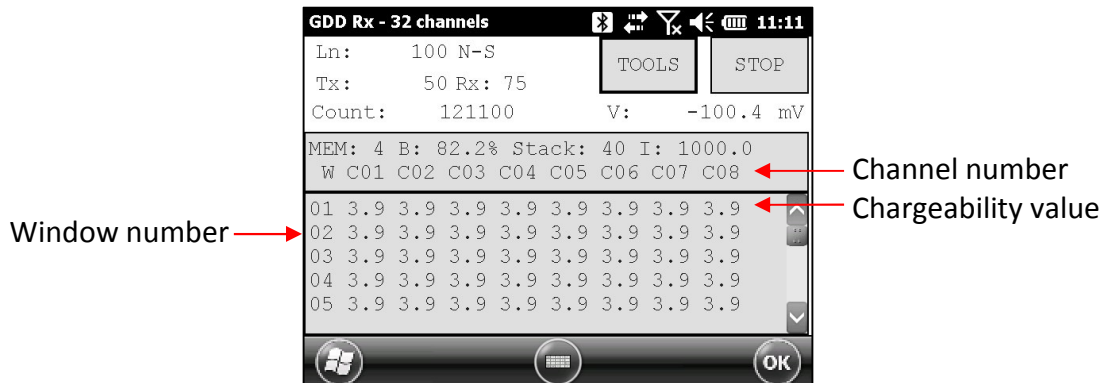

8.3.9 Show Sp

Steps 14 to 16 of *Section 5* of this Manual must be done before using this feature.

The SHOW SP option is used to display the self-potential (SP) in mV of each channel.

1. Select Tools | Show | Show SP
Hotkey 'P'



2. The following screen appears.

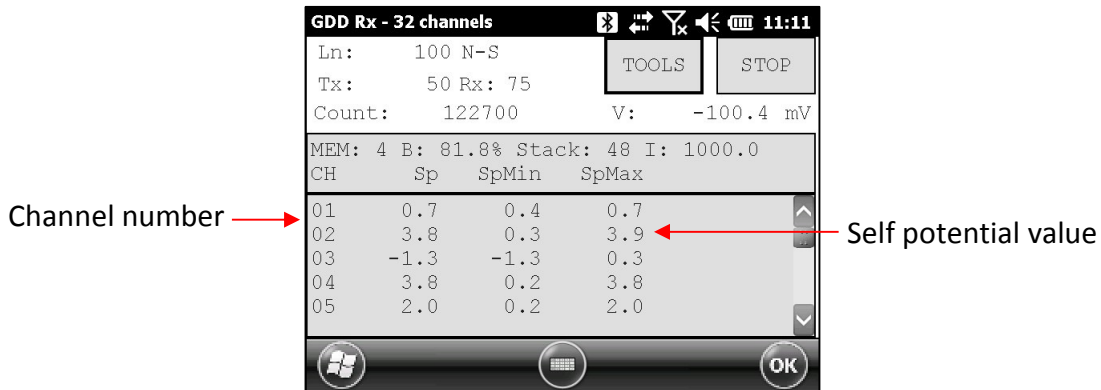

8.4 Raw Data Option

8.4.1 Check GPS

To use the GPS function, your receiver must be equipped with an internal GPS module. This GPS module is designed for use with applications that require accurate time (getting GPS timestamps in output files, synchronizing a receiver with a transmitter using GPS signal, recording raw data without synchronization for post processing, etc.).

The *Check GPS* option is used to verify if a satellite is being tracked by the GPS module.

Connect an external antenna (SMA) to the GPS connector of the GRx8-32 receiver for more efficiency.

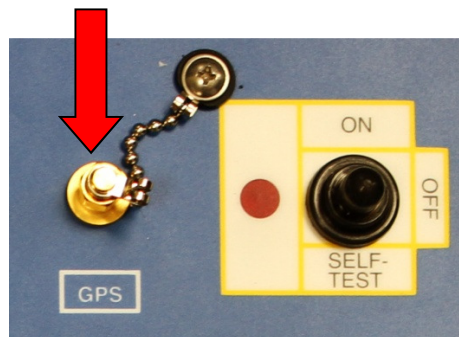

After turning on the GRx8-32 receiver, it can take up to 2 or 3 minutes for the GPS receiver to track and synchronize with a satellite.

Important: the internal GPS module of the receiver can take up to 15 minutes to get the UTC time. Wait for this time before taking your first reading if your receiver needs to get the same GPS time than another device.

Select Tools | Raw Data | Check GPS

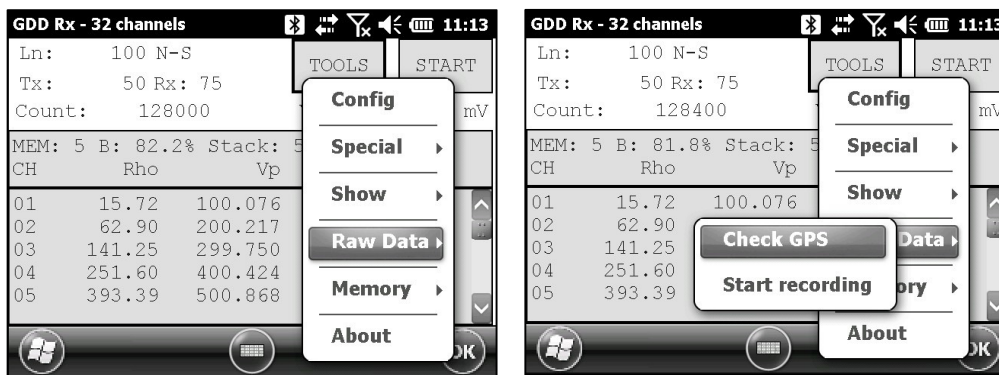

If the GPS module is not synchronized with a satellite, the following window will appear.

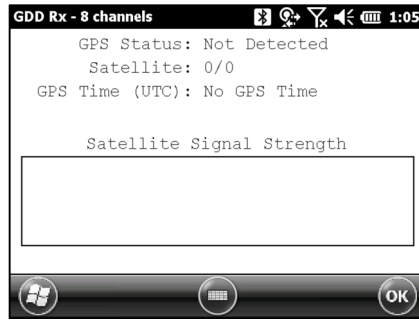

Once the GPS module is synchronized with a satellite, the following window should appear.

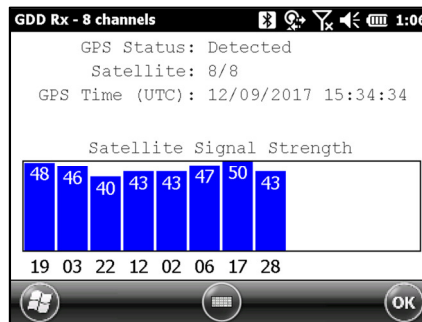

This window allows you to verify if the GPS works properly. You can close this window and continue to work normally with your GRx8-32 receiver. You can occasionally verify if the GPS is still tracking the satellite.

The GPS timestamps will appear in the *.gps* file (see Section 8.5.5 to create a *.gps* file). The data in this file is the same than that of the *.gdd* file except for the GPS timestamp (the time in the *.gdd* file comes from the PDA).

Example of *.gps* file

```
Version PPC: 0.4.2.39 Version Rx: 8.1.0.0 Rx SN: 1266
Project: Project
Windows: 20 Setting: Arith. Delay (ms): 240 Timing (ms): 80, 80, 80, 80, 80, 80, 80, 80, 80, 80, 80, 80, 80, 80, 80, 80, 80, 80, 80, 80, 80
Mem Date Hour GPS SyncBy Array LineTx LineRx Dir n Tx1 Tx2 Rx1
1 27/08/2015 15:00:07.049443 YES SIGNAL DP-DP 100.00 100.00 N-S 1.0 25.00 50.00 75.00
1 27/08/2015 15:00:07.049443 YES SIGNAL DP-DP 100.00 100.00 N-S 2.0 25.00 50.00 100.00
1 27/08/2015 15:00:07.049443 YES SIGNAL DP-DP 100.00 100.00 N-S 3.0 25.00 50.00 125.00
1 27/08/2015 15:00:07.049443 YES SIGNAL DP-DP 100.00 100.00 N-S 4.0 25.00 50.00 150.00
1 27/08/2015 15:00:07.049443 YES SIGNAL DP-DP 100.00 100.00 N-S 5.0 25.00 50.00 175.00
1 27/08/2015 15:00:07.049443 YES SIGNAL DP-DP 100.00 100.00 N-S 6.0 25.00 50.00 200.00
1 27/08/2015 15:00:07.049443 YES SIGNAL DP-DP 100.00 100.00 N-S 7.0 25.00 50.00 225.00
1 27/08/2015 15:00:07.049443 YES SIGNAL DP-DP 100.00 100.00 N-S 8.0 25.00 50.00 250.00
2 27/08/2015 15:03:47.001726 YES SIGNAL DP-DP 100.00 100.00 N-S 1.0 25.00 50.00 75.00
```

If there is GPS synchronization with a satellite, the column GPS will show YES as shown on the picture above. See Section 8.1.4 to know more about SyncBy column.

During the acquisition process, the GPS status is available by selecting Tools | Raw Data | Check GPS:

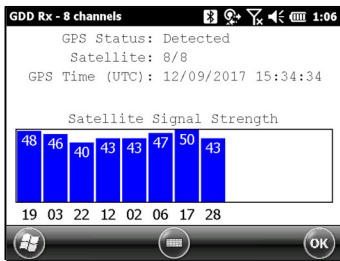

GPS well synchronized

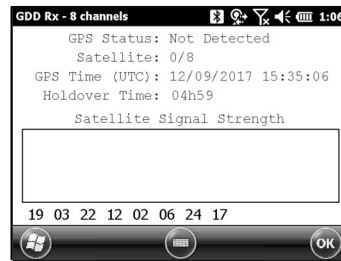

GPS signal lost for less than 5 hours

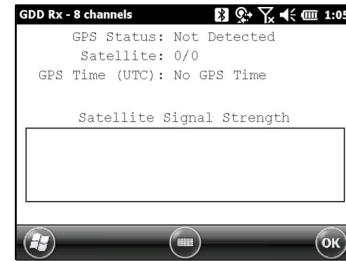

No GPS signal from the beginning or lost for more than 5 hours

8.4.2 Start Recording (raw data)

This option is used to record raw data without any synchronization with a transmitter signal. This can be useful to record the telluric or noise from the ground.

The receiver will record a reading every 20 ms. Thanks to the GPS module, each recorded reading will be accurately time stamped. Your receiver must be equipped with an internal GPS module to use GPS with the raw data function.

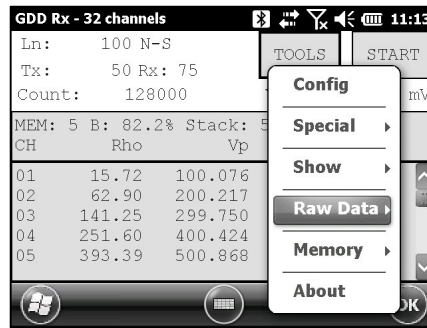

1. Make sure that channel 1 or R1 is connected to the ground.

If a pole configuration is selected in the Setup – Config menu, make sure that channel R1 is connected to the ground.

If a dipole configuration is selected in the Setup – Config menu, make sure that channel 1 is connected to the ground.

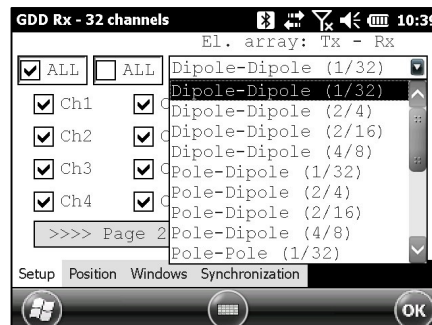

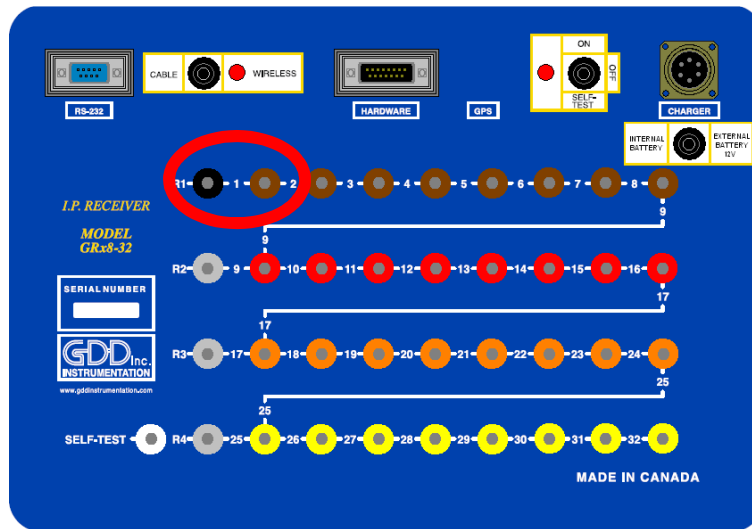

2. If you want to verify the GPS time, select Check GPS.



If you see No GPS Time, either the internal GPS module cannot receive any data from a satellite, or your receiver does not have this option.

- To begin the data acquisition, select Tools | Raw Data | Start recording.

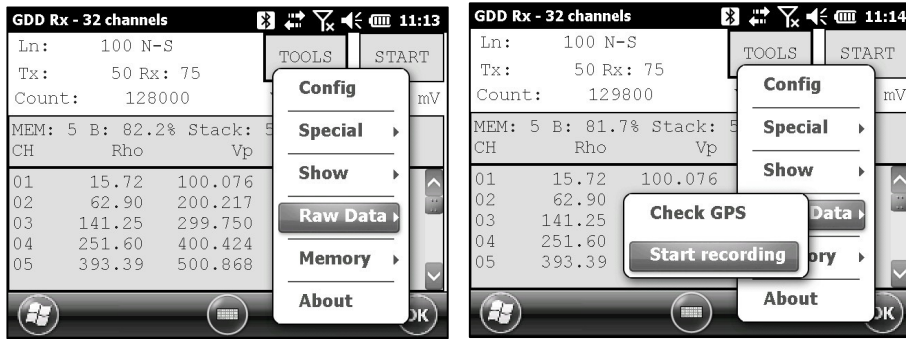

- You will be prompted to name your file.

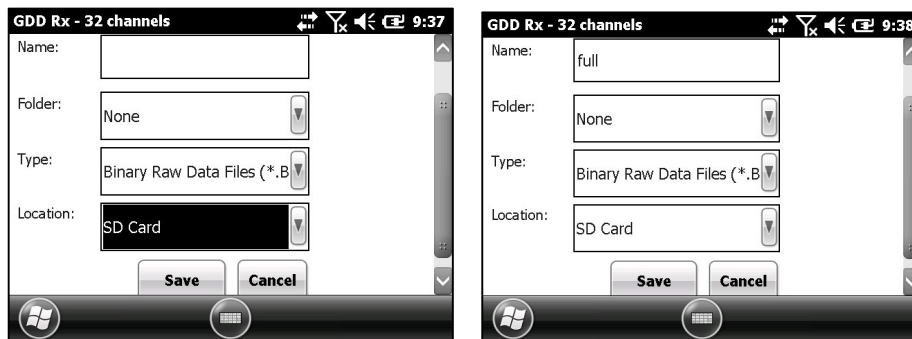

- The following icon will appear and data will be recorded until you stop the acquisition by selecting Tools | Raw data | Stop recording.

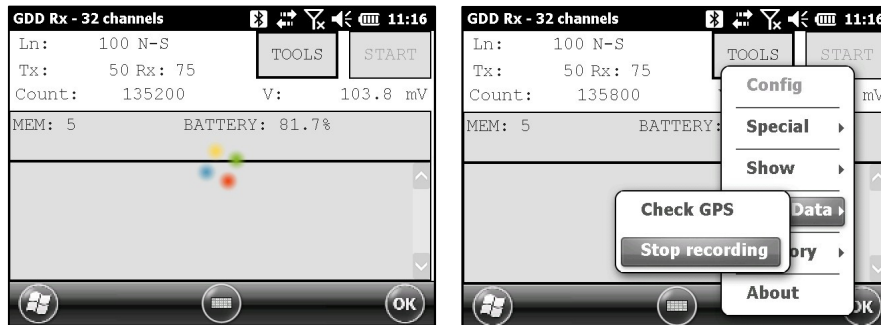

The extension of the file created with your raw data is *' .bdf '*. This binary format file can be imported and visualized using GDD's IP Post-Processing software.

8.5 Memory Option

8.5.1 Display Reading

The Display Reading option displays a particular reading on the PDA as the operator would see it in the field even if no receiver is connected to the PDA.

Select Memory | Display Reading

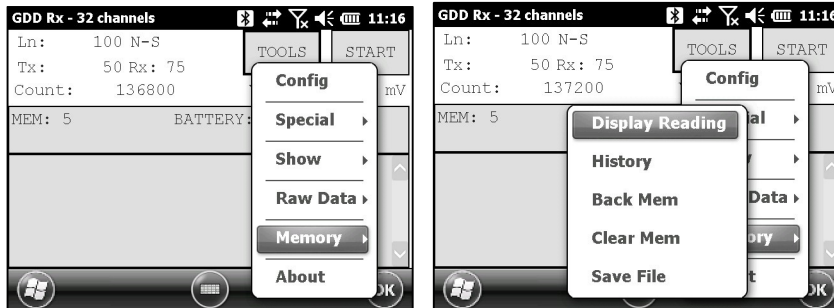

The following window will appear. The number in the *Reading Number* field is always the Memory number of the latest reading taken. Enter the number of the reading you want to see. Click on CONFIRM.

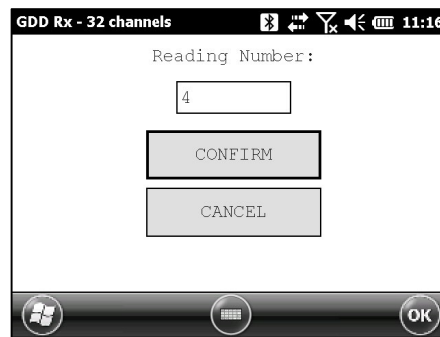

Select the Windows of chargeability. Click on CONFIRM.

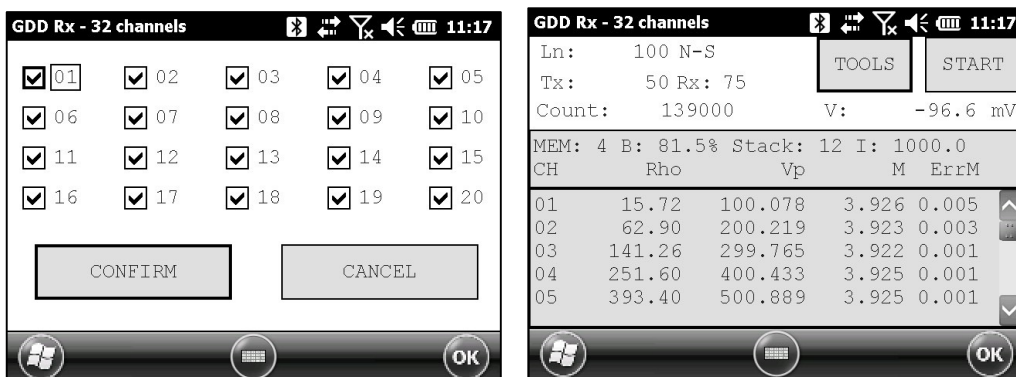

Use Left and Right arrow buttons to compare your current data with that of your previous acquisitions. Use the Up and Down arrows to see all the channels.

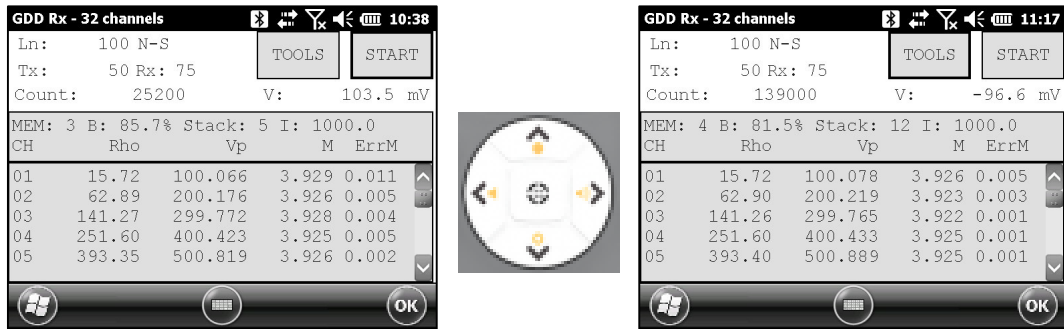

Keep in mind that there is no indication of which reading is monitored on the PDA display. At this point, it is possible to use the Hotkeys or the Show menu to display graphs or channel values.

8.5.2 History

The History option is used to display all the data accumulated in memory.

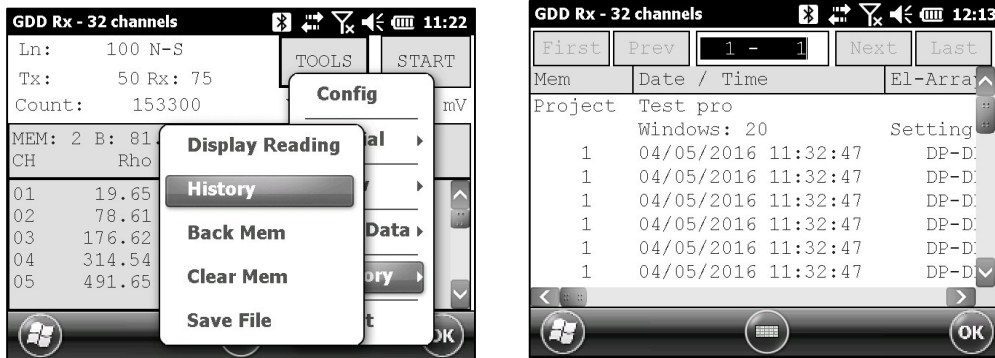

You will have to use the scroll bar to see all the information available. Click Next to go to the next page. The three following slides show all the information displayed by the history.

History																
Version PPC: 0.3.3.4 Version Rx: 0.2.3.1 Rx SN: 1042																
Project: Tests GRx8-32																
Windows: 20 Setting: Arith. Delay (ms): 240 Timing (ms): 80, 80, 80, 80, 80, 80, 80, 80, 80, 80, 80, 80, 80, 80, 80, 80,																
Mem	Date	/	Time	El-array	LineTx	LineRx	Dir	Tx	Tx	Rx	Rx	Contact	Rho			
1	20/03/2008		11:11:41	P-P	0.00	0.00	N-S	999999.00	50.00	75.00	999999.00	INFINI	6.20			
History																
80, 80, 80, 80, 80																
Sp	SpMin	SpMax	Vp	ErrVp	Sym(%)	M	ErrM	In	Time	DC	Stack	M01	M02	M03	M04	M05
-173.8	-330.2	-17.4	0.039	99.999	58	-727.92	99.99	1.0	2000	50	1	999.99	815.34	786.02	606.62	139.14
History																
M06	M07	M08	M09	M10	M11	M12	M13	M14	M15	M16	M17	M18	M19	M20		
-894.78	-104.95	-437.02	-803.81	-684.56	-951.07	-944.17	-999.99	-999.99	-999.99	-999.99	-999.99	-999.99	-999.99	-999.99	-999.99	

8.5.3 Back Mem

The *Back Mem* option is used to clear the last readings of the memory one by one.

1. Select Tools | Memory | Back Mem

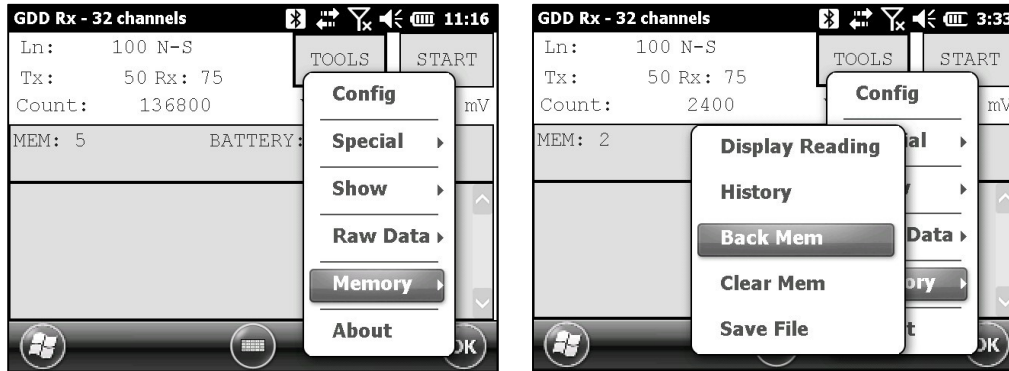

2. Click Yes to clear the last readings.

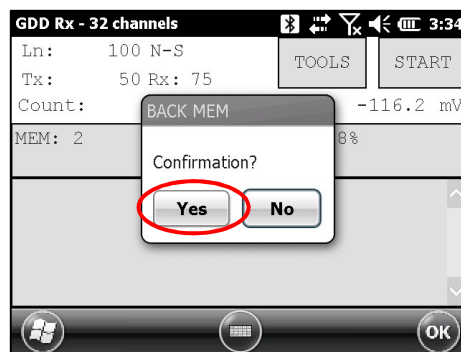

8.5.4 Clear Mem

The *Clear Mem* option is used to clear all the readings of the memory.

1. Select Tools | Memory | Clear Mem

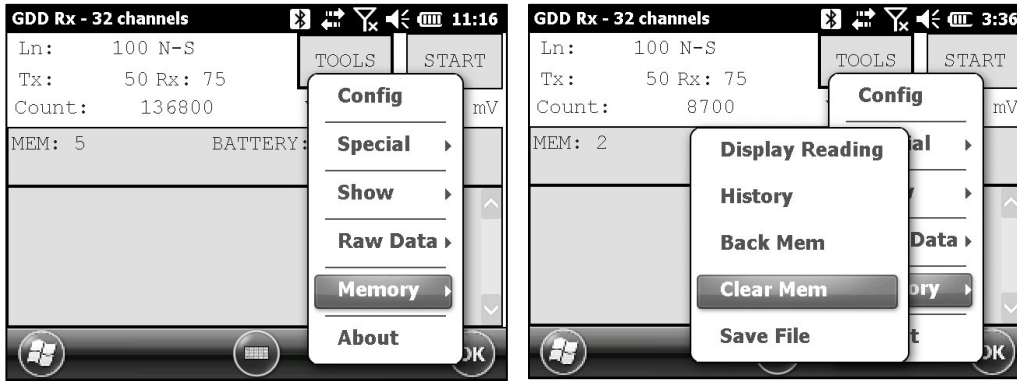

2. Click Yes to confirm the operation.

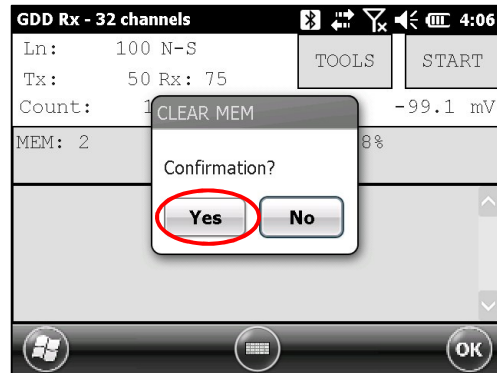

3. Enter 9999 in the text box.



4. Click *Confirm* to clear all the readings of the memory.

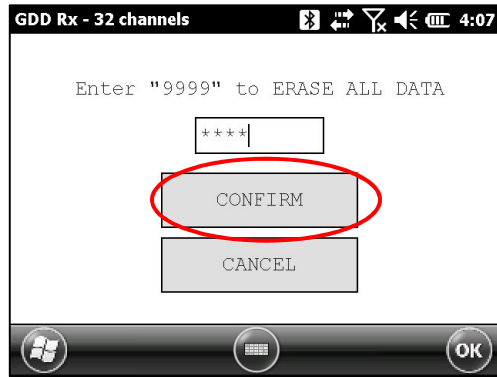

5. A message will follow to confirm your operation.

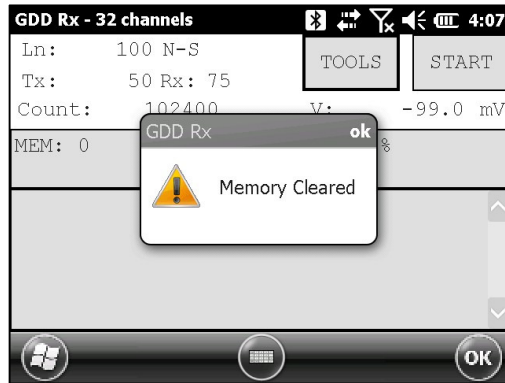

8.5.5 Save File

The *Save File* option is used to save the readings to a file.

1. Select Tools | Memory | Save File

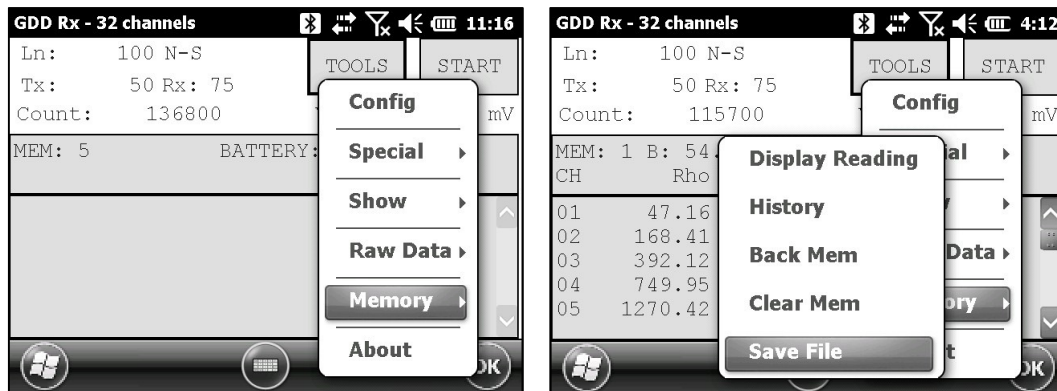

2. Select the output file format available according to your electrode configuration (only one output file format could be available). A GDD Generic file is always created even if you choose another format.

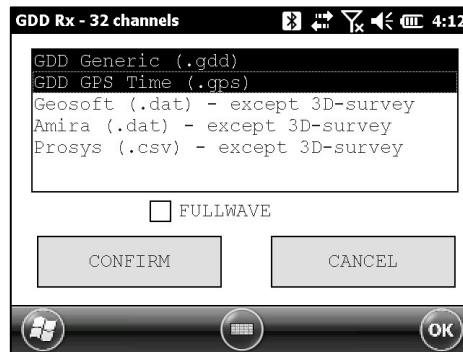

3. Check the *FULLWAVE* check box if you want to create the *ascii* format fullwave file and click CONFIRM.

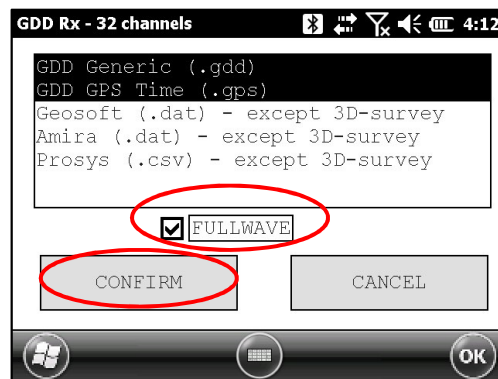

Saving the FULLWAVE file will take significant time. We recommend to copy the .mem file from the PDA to you computer and to create this file using the IP Post-Process software.

4. Select the file location.

It is recommended to save your files in the SD Card folder to make sure that you will have enough disk space. Do not save the data in the My Documents folder.

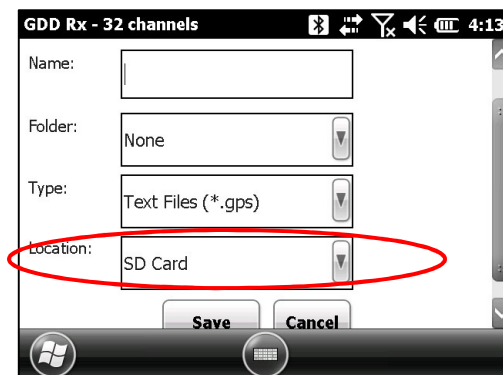

5. Enter the file name and click **Save** (the saving operation can take several minutes).



6. One of the following screens appears; click **OK** to close the pop up dialog box.

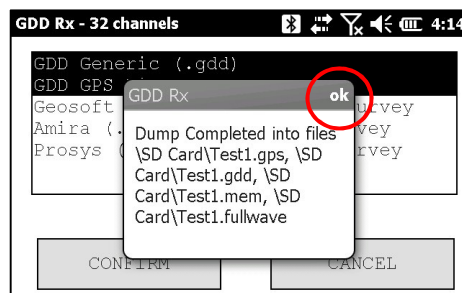

The *.mem* file, as the *.gdd* file, is automatically created by the system. The *.mem* file has a specific format required to be used with the new GDD IP Post-Process software. Contact GDD for more information about this new software.

If using the GDD-RTE01 communication boxes, an *ascii* file (*gdd_rte.log*) will be created at the same location than your IP data. This *gdd_rte.log* file contains the output current and power values broadcasted by the GDD IP transmitter (model Tx4).

***** WARNING *****

The Allegro² sometimes does not detect the memory card and records the GDD_RxPP_MEM data file somewhere else in the PDA. If part of the memories has been acquired without detecting the SD card and another part with detecting the SD card, the Rx software creates auxiliary files with **_aux** at the end of their name. These auxiliary files contain the part of the data that was not saved directly to the compact flash card. You must transfer all these output files from your Allegro² to your computer to prevent loss of data.

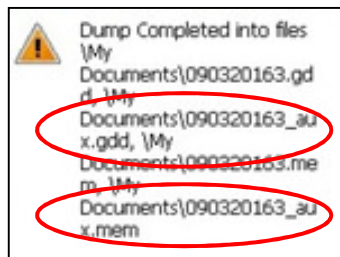

8.6 About Option

The *About* option is used to display the software version number.

1. Select Tools | About

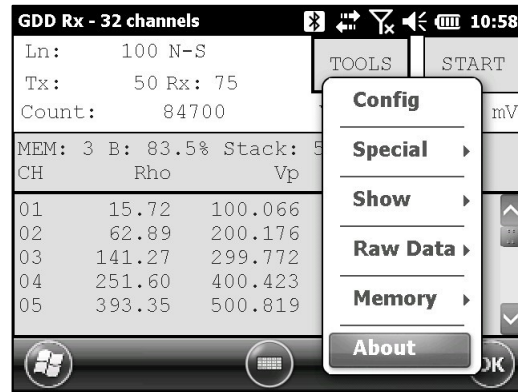

2. The following screen appears.

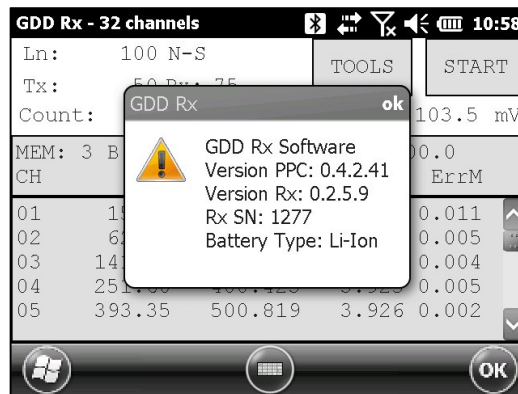

*See Section 8.2.4 for more information about *Battery Type*.

9. Transferring data

To establish communication between the Allegro² and a desktop PC, you need to install the appropriate synchronisation software.

Windows 7, 8 or Vista 64 bits users will require Windows Mobile 64 bits while Windows 7, 8 or Vista 32 bits users will need to install Windows Mobile 32 bits. Refer to the “*Sync PDA on Windows 10.pdf*” document located on the CD-ROM / USB stick if you experience problems using Windows 10. Install ActiveSync if you run Windows XP or earlier.

All three programs are available on the CD / USB stick supplied by GDD.

Another way of transferring data between your Allegro² and your PC is to set the PDA device as a USB connection. Refer to the detailed sections below.

9.1 ActiveSync

9.1.1 Installation and settings

1. Once ActiveSync is installed, a gray icon will appear in the bottom right corner of your desktop PC screen.



2. Right click on the *ActiveSync* icon to open the following menu and select *Connection Settings...*

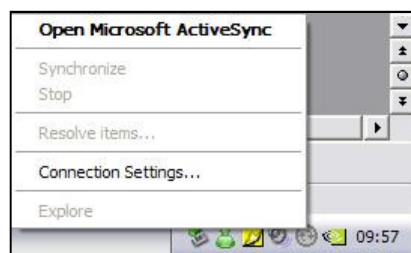

3. Check *Allow USB connection with this desktop computer.*



9.1.2 Establishing connection with a desktop PC

1. Turn the PDA ON



2. Connect the micro USB communication cable between the Allegro² and the desktop PC.



3. The desktop *ActiveSync* icon is now green.



4. A small *PCLink* icon appears on the Allegro² title bar.

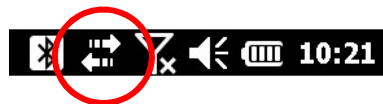

9.1.3 Transferring file(s) from the Allegro² to a desktop PC

1. Double click on the *My Computer* icon on your desktop PC.



2. Double click on the *Mobile Device* icon.



3. Double click on the SD Card folder (if that is where you saved your files).

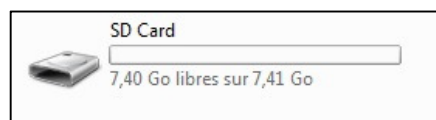

4. Use the drag and drop; or cut, copy and paste functions to move file(s) from your Allegro² to your desktop PC.

The GDD Generic data file is named: File_Name.gdd

The GDD binary file is named: File_Name.mem

If created, the fullwave file is named: File_Name.fullwave

* See *Section 8.5.5 -SAVE FILE* for more information about alternate output formats and creating a FULLWAVE file.

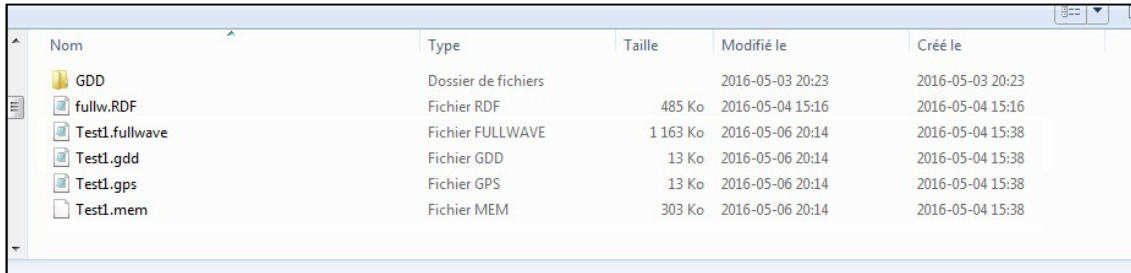

The screenshot shows a Windows File Explorer window with a table of files. The table has five columns: Nom, Type, Taille, Modifié le, and Créé le. The files listed are:

Nom	Type	Taille	Modifié le	Créé le
GDD	Dossier de fichiers		2016-05-03 20:23	2016-05-03 20:23
fullw.RDF	Fichier RDF	485 Ko	2016-05-04 15:16	2016-05-04 15:16
Test1.fullwave	Fichier FULLWAVE	1 163 Ko	2016-05-06 20:14	2016-05-04 15:38
Test1.gdd	Fichier GDD	13 Ko	2016-05-06 20:14	2016-05-04 15:38
Test1.gps	Fichier GPS	13 Ko	2016-05-06 20:14	2016-05-04 15:38
Test1.mem	Fichier MEM	303 Ko	2016-05-06 20:14	2016-05-04 15:38

5. Open the saved files with Notepad or Excel.

9.2 Windows Mobile Device Center

9.2.1 Installation and settings

1. Once Windows Mobile Device Center 32 or 64 bits is installed, click the Windows Start Menu icon and then click *All Programs* to display all installed programs. Click *Windows mobile Device Center* to launch the application.

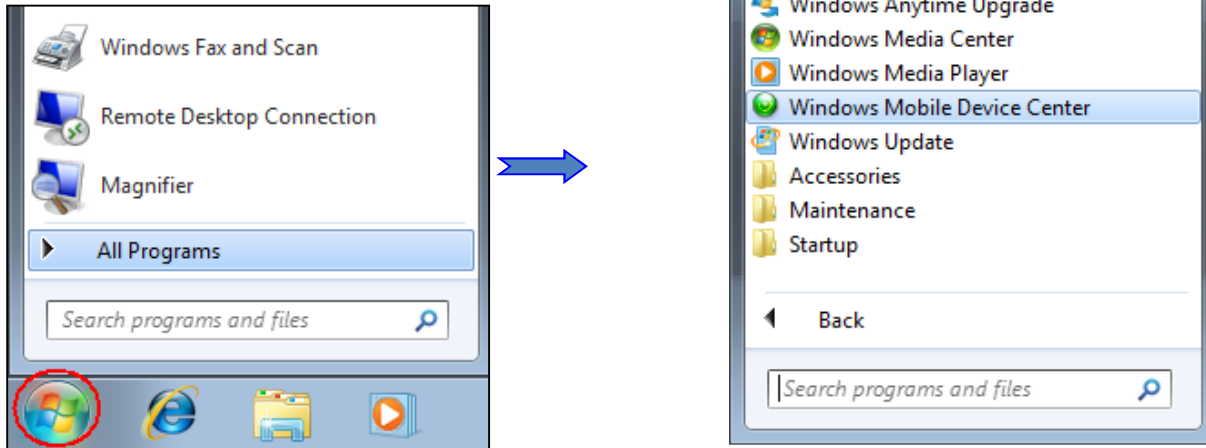

2. Under the *Mobile Device Settings* option, click on *Connection settings*.

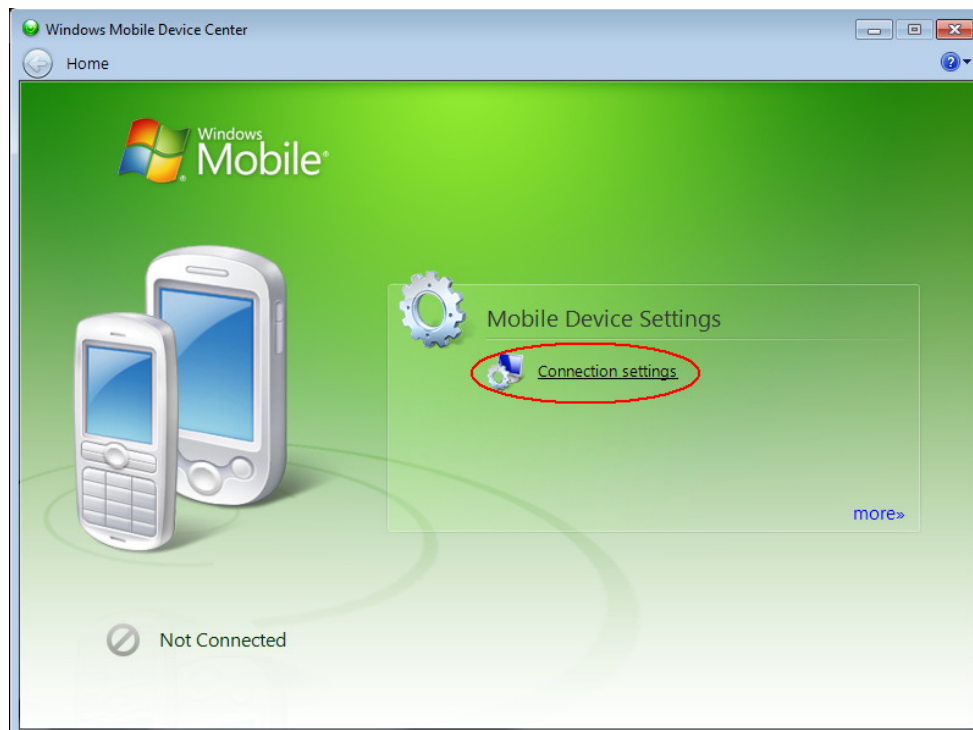

3. Check *Allow USB connections*.

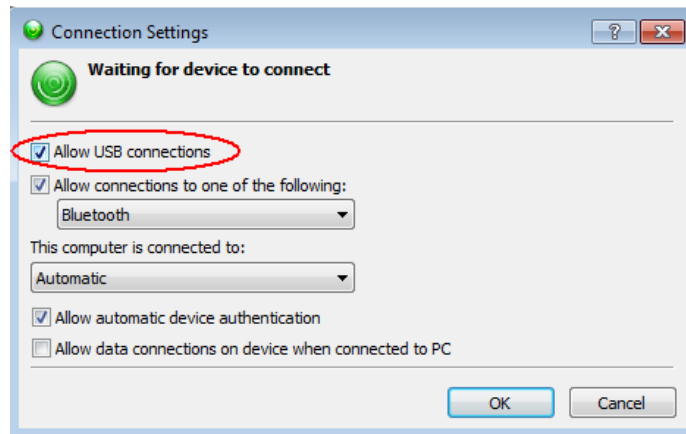

9.2.2 Establishing connection with a desktop PC

1. Connect the micro USB cable between the Allegro² and the desktop PC.



2. Turn the PDA *ON*.



3. The Windows Mobile Device Center application will connect with the PDA.



4. A small *PCLink* icon appears on the Allegro² title bar.



9.2.3 Transferring file(s) from the Allegro² to a desktop PC

1. From the Windows Mobile Device Center, click *Connect without setting up your device*.



2. Click *Browse the content of your device* under the *File Management* section.



3. Double click on the SD Card (if that is where you saved your files).

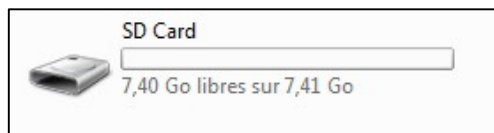

4. Use the drag and drop; or cut, copy and paste functions to move file(s) from your Allegro² to your desktop PC.

The GDD Generic data file is named: File_Name.gdd

The GDD binary file is named: File_Name.mem

If created, the fullwave file is named: File_Name.fullwave

* See *Section 8.5.5 (SAVE FILE)* for more information about alternate output formats and creation of the FULLWAVE file.

Nom	Type	Taille	Modifié le	Créé le
GDD	Dossier de fichiers		2016-05-03 20:23	2016-05-03 20:23
fullw.RDF	Fichier RDF	485 Ko	2016-05-04 15:16	2016-05-04 15:16
Test1.fullwave	Fichier FULLWAVE	1 163 Ko	2016-05-06 20:14	2016-05-04 15:38
Test1.gdd	Fichier GDD	13 Ko	2016-05-06 20:14	2016-05-04 15:38
Test1.gps	Fichier GPS	13 Ko	2016-05-06 20:14	2016-05-04 15:38
Test1.mem	Fichier MEM	303 Ko	2016-05-06 20:14	2016-05-04 15:38

5. Open the saved files with Notepad or Excel.

9.3 USB connection

1. In the main screen of the Allegro², go in the Settings menu.

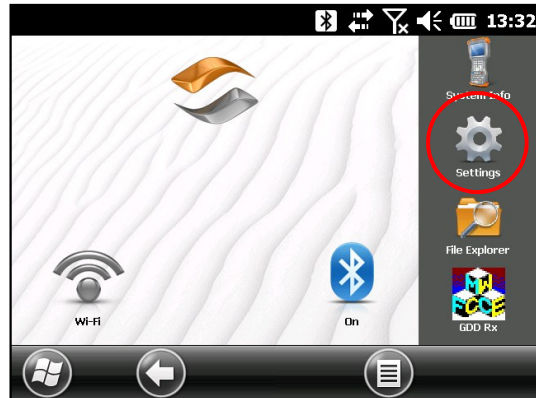

2. Go in the "connections" folder and then select the "USB to PC option".



3. Select "SD Card - Use as external drive (Mass Storage)"

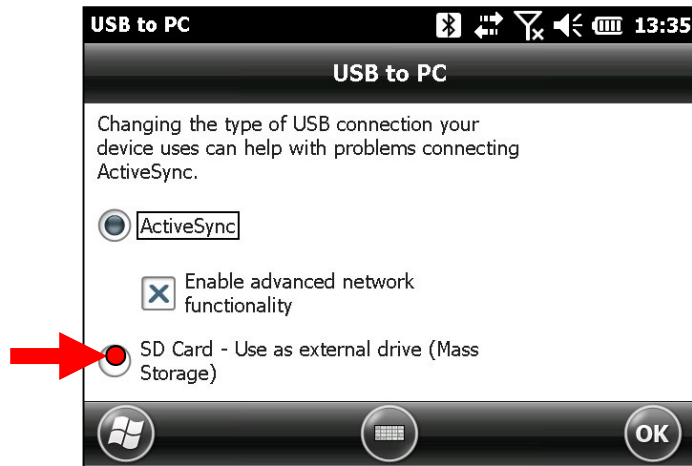

4. The Allegro² can now be accessed from the Windows File Explorer:



10. Bluetooth configuration

1. In the Home screen of the Allegro², click on the Bluetooth icon to turn the Bluetooth on.



2. Tap on the Title bar at the top of the screen to display the pop-up icons and click on the Bluetooth icon.

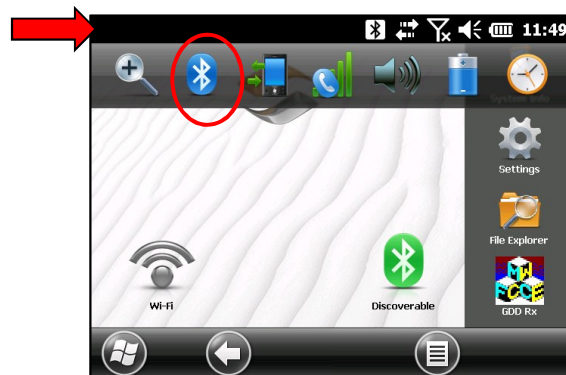

3. Click on *Add new device*. Your GDD IP receiver must be on and in wireless mode.

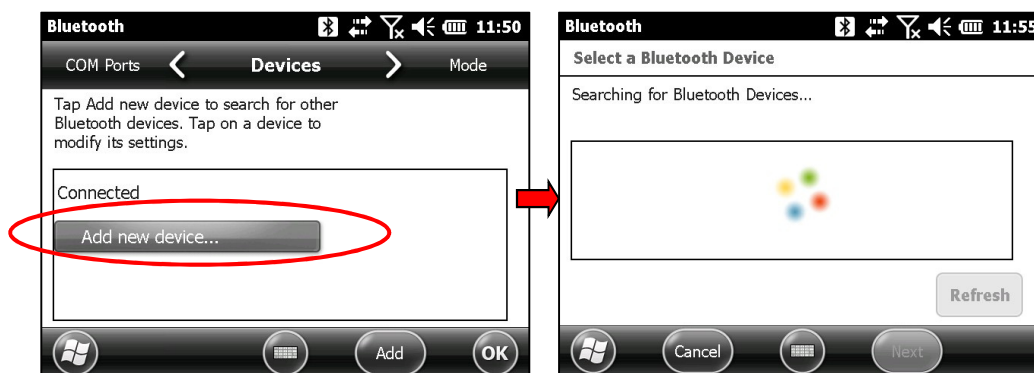

4. Select your device (the serial number of your receiver), and click *Next*.

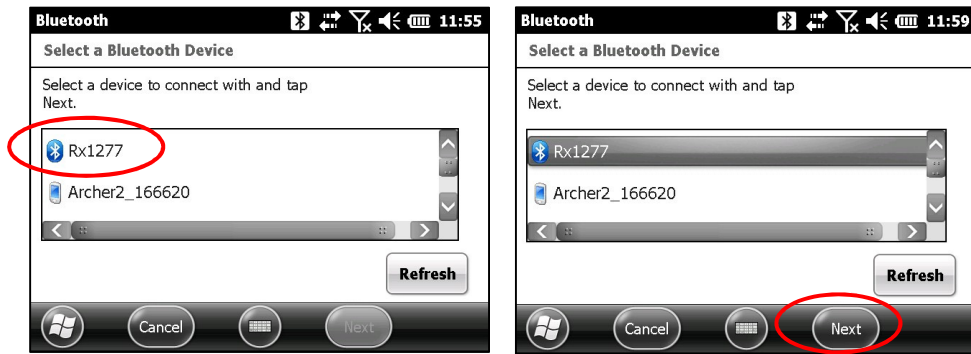

5. Enter the passkey *1234*, and click *Next*. The *Device Added* window appears for a few seconds. Click on *Advanced* and go to step 8.

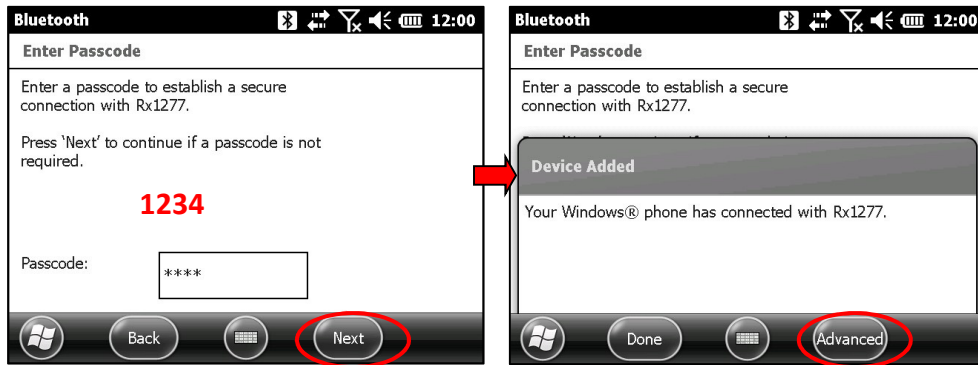

6. Or, click on your device (the serial number of your receiver) to modify its settings.



7. Check *Serial Port* and click *Save*.

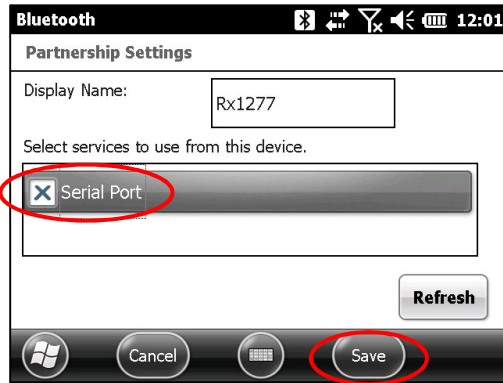

8. Click on *COM Ports* and select *New Outgoing Port*.



9. Select your device (the serial number of your receiver) and click *Next*.

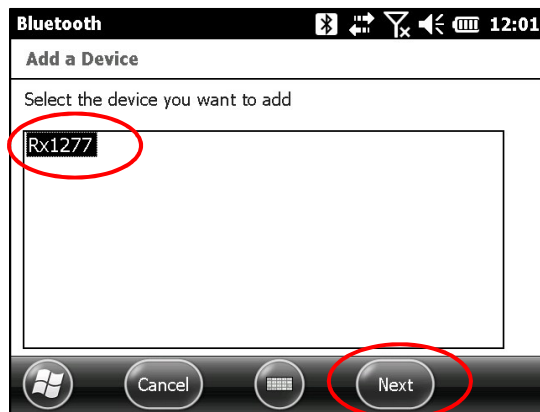

10. Select *COM9* and check *Secure Connection*. Click *Finish*.

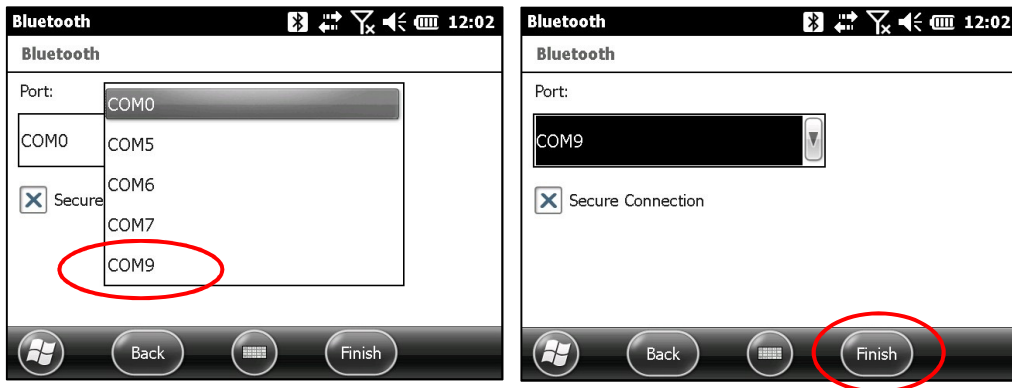

11. Click *OK* to close the Bluetooth settings.

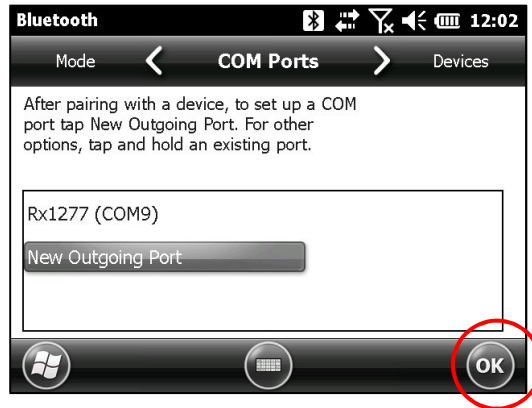

11. GDD Rx software update

1. Connect the micro USB cable between the Allegro² and the desktop PC.



2. Double click on the *My Computer* icon on your PC's desktop.



3. Double click on the *Mobile Device* icon. Pictures could be different depending on your computer's operating.



4. Double click on the main directory. (Could be *My Handheld PC* on another operating system).

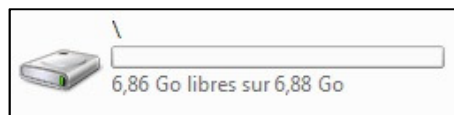

5. Double click on the *Program Files* folder.



6. Double click on the *GDD* folder.



7. Delete the old files. Use the drag and drop, or the copy and paste functions to move the new GDD Rx software files from your computer to your Allegro².

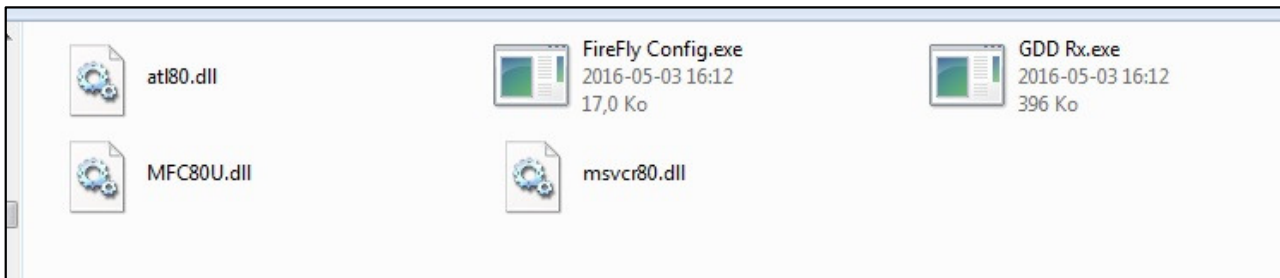

12. Troubleshooting

This section suggests problems that could occur while using the GDD Rx8-32 and their solutions.

For any issues regarding the Allegro² field computer other than those related to the GDD program, please refer to the Allegro²'s user manual available on the CD-ROM / USB stick provided by GDD.

➤ Problem:

The receiver is not ON when the On-Off switch is at 'On'.

✓ Answer:

- In Cable mode, the receiver will only be ON when the GDD Rx program is active on the pocket PC.
- If the receiver's battery power rating is below the critical threshold, the receiver will not turn on. (See *Section 4 - Power* for more details.)

➤ Problem:

The Internal Battery Label on the receiver panel does not light when the power supply is connected to the receiver.

✓ Answer:

- Verify if the battery is already fully charged. If the batteries are full, the light does not turn on.
- Verify that the 120V or 240V (black) power cable is plugged into the power supply and that it is connected to a power source.
- Verify that the connector is properly inserted into the power supply connector.
- Verify that the "Internal battery / External battery" switch is on "Internal battery".
- Verify that the power supply is working properly: unplug the power supply from the receiver and from its power source. Plug it into the power source again and the green light should turn on.

➤ Problem:

The message: 'GDD Rx – No Receiver' is shown in the program bar of the GDD Rx program. It stays on the bar even if the Allegro² is connected to the receiver.

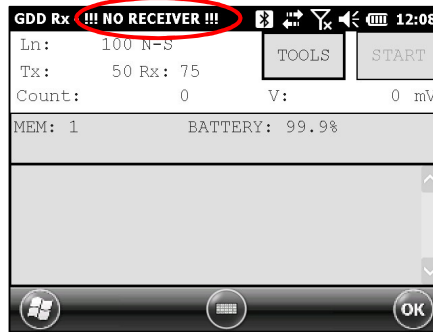

✓ Answer:

- Check that the receiver's On-Off switch is at On and that the LED is on.
- Verify that the receiver's batteries are powered enough and not within the critical threshold limit.
- In Cable mode, verify that the cable is plugged correctly into the receiver and into the Allegro² pocket PC. If you are using the D-SUB 9 to D-SUB 9 cable, try replacing the cable to a D-SUB 9 to Amphenol 6 cable (or the opposite if you were using a D-SUB 9 to Amphenol 6 as your primary cable).
- In Cable mode, make sure your cable is connected to the COM1 port of the Allegro² pocket PC.
- In Bluetooth mode, this can happen if the Bluetooth module of the PDA did not close its virtual communication port properly. Close the GDD Rx program and turn off the receiver. Wait for about 10 seconds and then, turn on the receiver and try to restart the GDD Rx program in Bluetooth mode.
- If the program still not detects the receiver in Bluetooth mode, open the program in RS232 mode and save all your data. When your data is saved, push and hold the ON button of the Allegro² to reset it.

➤ Problem:

In Bluetooth mode, the following message appears.

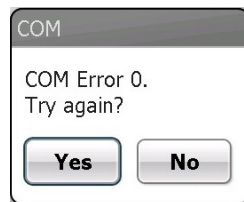

✓ Answer:

- Make sure that the Cable / Wireless switch is in the Wireless position and that the receiver is turned on.
- Verify that your Allegro²'s Bluetooth is ON. If the Bluetooth is Off, see *Section 10.1* to turn it on.

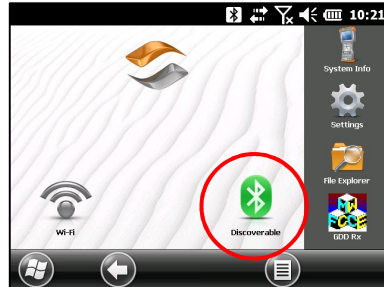

- See *Section 10.1* to find out how to verify if a partnership has been established between your receiver and your Allegro².
- Reset your Allegro² by pressing and holding the Power button. The following message appears. Select Reset.

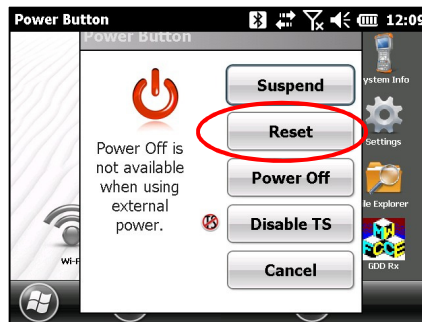

➤ Problem:

A synchronization error message appears while synchronizing with the receiver.

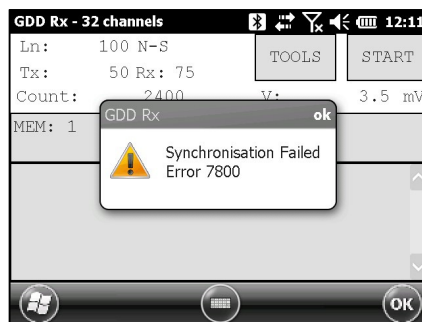

✓ Answer:

- Make sure that the Timing and the Duty Cycle of the receiver corresponds to the Time base and the Duty Cycle of the transmitter.

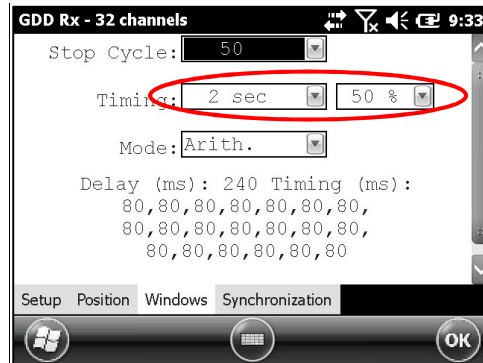

- Check if the signal ($V_p > 2$) of the trigger channel is high enough. Otherwise, try to synchronize with another channel. You should select the channel that receives the higher signal as the trigger channel.

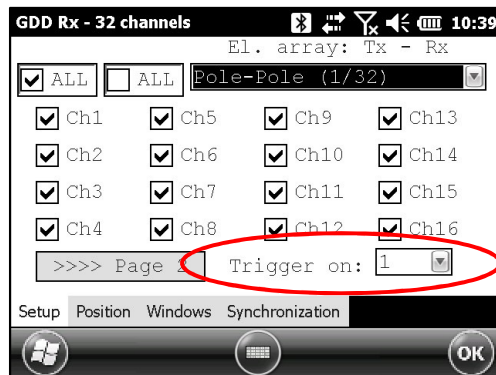

- Check if the transmitter works properly. If the transmitted signal is asymmetrical, the receiver may not synchronize.

➤ Problem:

A warning red rectangle appears in the main window during the acquisition process. If you click on the red rectangle, a saturation message appears.



✓ Answer:

- If this message appears, it means that the signal on some of the channels is higher than 15 volts. The channels of the receiver are protected against voltage up to 500V but they can read a Vp of up to 15V only. To prevent the voltage saturation, you can try to reduce the transmitted current at the transmitter.

➤ Problem:

Creating files or transferring files takes too much time.

✓ Answer:

- The size of the fullwave file explains the export time on the PDA. We have developed an IP Post-Process software and we could recommend using this tool to generate the fullwave files instead of doing it on the PDA. It will speed up the export process.

You will find the software and the instructions on the CD-ROM / USB stick provided by GDD. Or contact GDD technical support for more information.

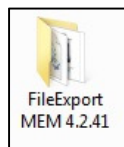

➤ Problem:

It is not possible to start Windows Mobile Device Center and transfer the IP data from the Allegro for computer operating under *Windows 10*.

✓ Answer:

- Refer to the “Sync PDA on Windows 10.pdf” document located on the CD-ROM / USB stick provided by GDD.

➤ Problem:

After carrying out a reset of the PDA, the MEM number indicates 0 even though a certain number of acquisitions have already been made.

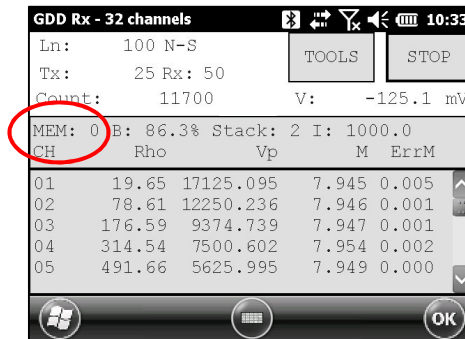

✓ Answer:

- On rare occasions, the PDA does not detect the memory card after reinitialization (or when starting the GDD_Rx software very shortly after turning the PDA ON) and this is why the MEM number is back to 0.

When this happens, you need to exit the GDD_Rx software, wait 15 seconds and start the application again. The MEM should be back to its original count.

Newer versions of the GDD_Rx software (4.2.43) include an automatic detection and the MEM count should be back to its expected value within a minute or so. A ! sign will appear in front of the MEM number if the memory card is not detected.

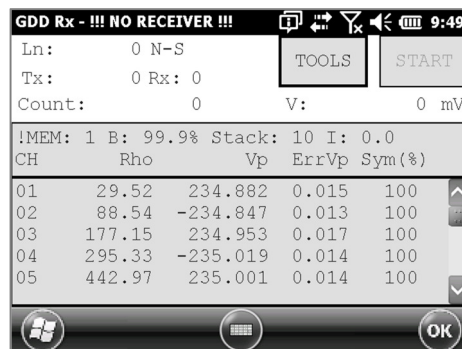

13. Specifications

General specifications

Number of channels:	8, 10, 16, 24 or 32
Size (receiver only):	41 x 33 x 17 cm (16 x 13 x 7 in)
Weight (receiver only):	7 kg (15 lbs)
Enclosure:	Heavy-duty Pelican case, environmentally sealed
Communication options:	RS-232 (serial) and Bluetooth to communicate with a PDA USB for data download
Power supply:	14.4V 13.6Ah rechargeable Lithium-Ion internal battery 14.4V 13.6Ah rechargeable Lithium-Ion external battery pack (optional)
Temperature range:	-40 to +60°C (-49 to +140°F)
Humidity range:	Waterproof

Technical specifications

Survey capabilities:	Resistivity and Time domain IP
Twenty chargeability windows:	Arithmetic, logarithmic, semi-logarithmic, Cole-Cole and user defined
Synchronization:	Automatic re-synchronization Process on primary voltage Signal GPS time synchronization
Noise reduction:	Automatic stacking number
Computation:	Apparent resistivity, chargeability, standard deviation, and % of symmetrical Vp
Ground Resistance:	Up to 1.5 MΩ
Signal waveform:	Time domain (ON+, OFF, ON-, OFF)
Time base:	0.5, 1, 2, 4, 8 and 16 seconds

Input impedance:	5 GΩ at 0.125 Hz and 130 MΩ at 7 Hz
Primary voltage range:	±10 uV to ±15 V for any channel
Input Common-Mode Voltage range with respect to reference in dipole-dipole configuration:	±15 V
Protection:	500V (on each channel)
Input:	True differential for common-mode rejection in dipole configuration
Voltage measurement (Vp):	Resolution 1 μV Accuracy ≤ 0,15%
Chargeability measurement (M):	Resolution de 1μV/V Accuracy ≤ 0,4%
SP offset adjustment:	± 5 V, Automatic compensation through linear drift correction per steps of 150μ, with resolution of 1μV
Filter:	Eight-pole Bessel low-pass 15 Hz, Notch filter 50 Hz and 60 Hz

Reads up to 32 ch. simultaneously in poles or dipoles

PDA menu-driven software / simple to use

32 channels configuration allows 3D Survey:

- 4 lines X 8 channels – 2 lines X 16 channels –
- 1 line X 32 channels

Real-time data and automatic data stacking

Screen-graphics: decay curves, apparent resistivity, chargeability, Vp, pseudosection

20 programmable chargeability windows

One 24 bit A/D converter per channel

Internal test generator (Self-test mode)

For more details about the Allegro² rugged field PC specifications, read the Allegro² manual.

14. *Technical help*

If you encounter a problem not described in this manual, do not hesitate to contact **Instrumentation GDD Inc.** for help at:

Tel.: +1 (418) 877-4249
Fax: + 1 (418) 877-4054
Toll free line: 1-877-977-4249 (in Canada)
e-mail: support-technique@gdd.ca

Emergency out of business hours:

Pierre Gaucher: Home phone: + 1 (418) 657-5870
Cell phone: +1 (418) 261-5552

Régis Desbiens: Home phone: +1 (418) 658-8539
Cell phone: +1 (418) 570-3408

Any GDD IP Receiver that breaks down while under warranty or service will be replaced free of charge upon request for the duration of repairs, except for shipping fees. This service is subject to instrument availability but we have been able to honour this commitment up to now.

Printed in Canada in 2017

Version: manual-ip-receiver-2017-12-14-A2-EN.docx

Annex 1 – Geometrical parameters

This annex explains how to configure your receiver according to the selection of the electrode array.

Electrode array	Geometrical parameters to enter				Maximum number of dipoles
	Tx1	Tx2	Rx	Sep	
Dipole-Dipole	Tx1	Tx2	Rx	Sep	32
Pole-Dipole		Tx2	Rx	Sep	32
Pole-Pole		Tx2	Rx	Sep	32
Gradient	Tx1	Tx2	Rx	Sep	32
Wenner	Tx1	Tx2			1
Schlumberger	Tx1	Tx2		Sep	1

Tx1: Transmitter first electrode position

Tx2: Transmitter second electrode position

Rx: Receiver first electrode position

Sep: Separation between two receiver electrodes

Note: For all electrode arrays, the Tx line and the RX line(s) can be different.

Dipole-Dipole (1/32)

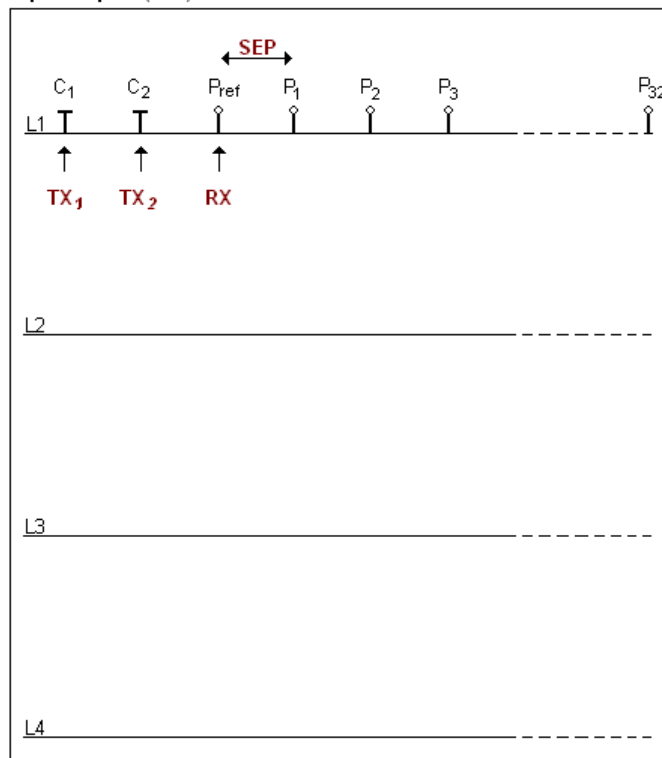

Dipole-Dipole (2/16)

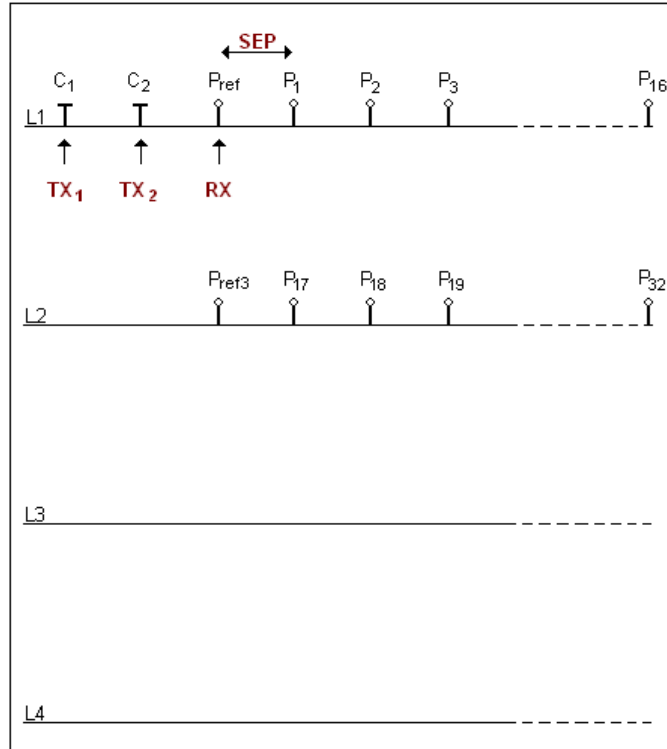

Dipole-Dipole (4/8)

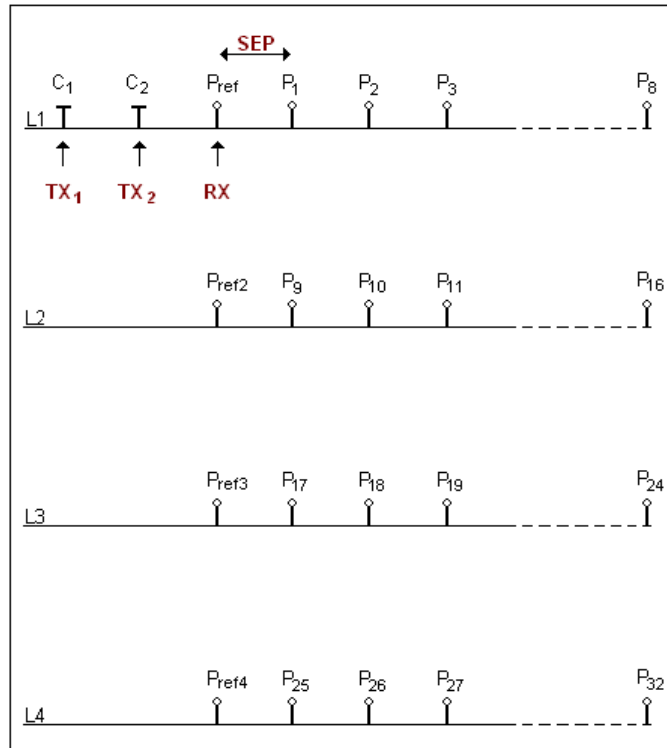

Pole-Dipole (1/32)

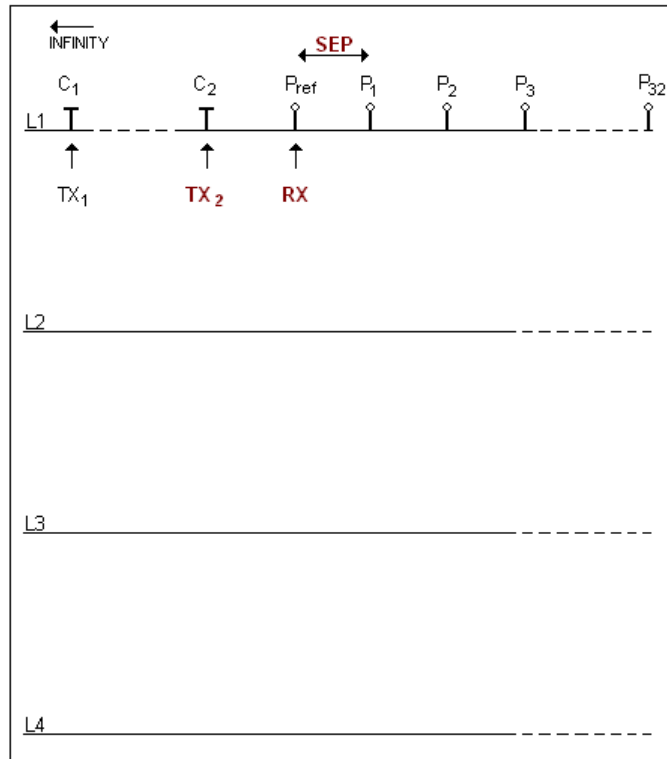

Pole-Dipole (2/16)

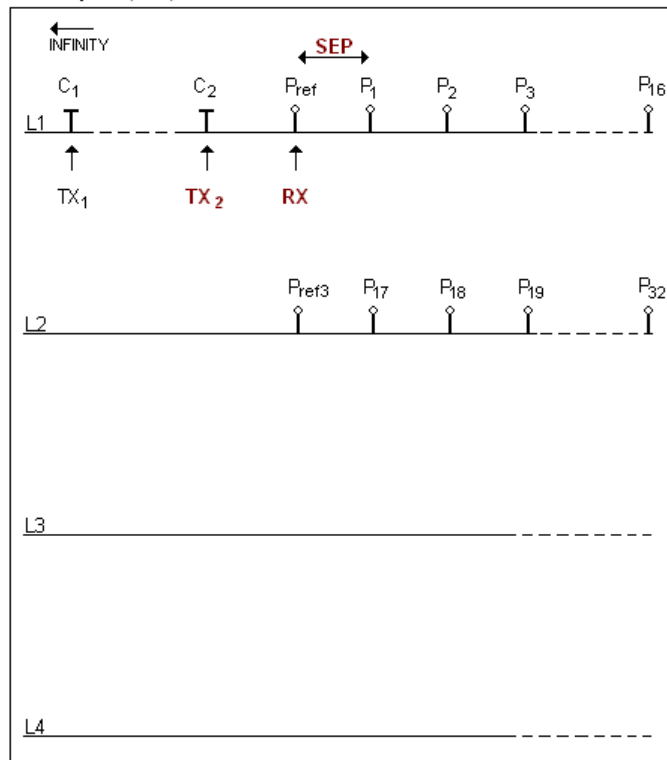

Pole-Dipole (4/8)

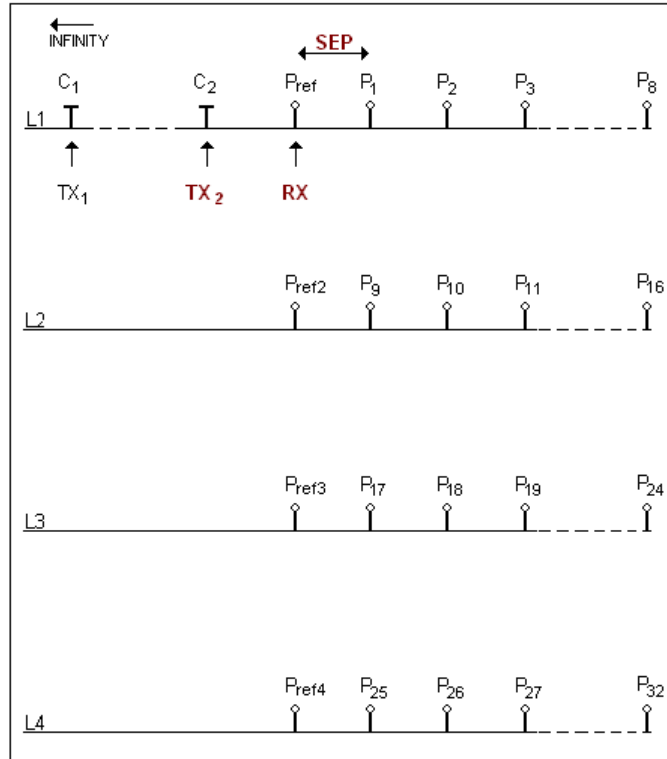

The electrode C₁ has to be set far from the other electrodes, usually 5 times the maximum distance between C₂ and P_{ref}.

Pole-Pole

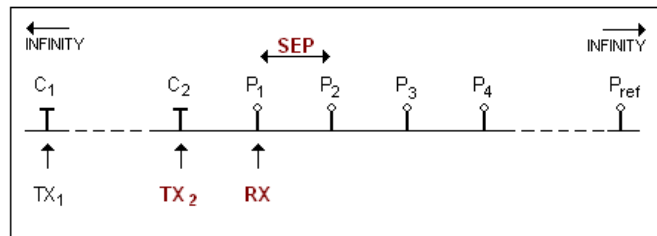

The electrodes C₁ and P_{ref} have to be set far from C₂ and P₁, usually 10 times the maximum distance between C₂ and P₁.

Gradient (1/32)

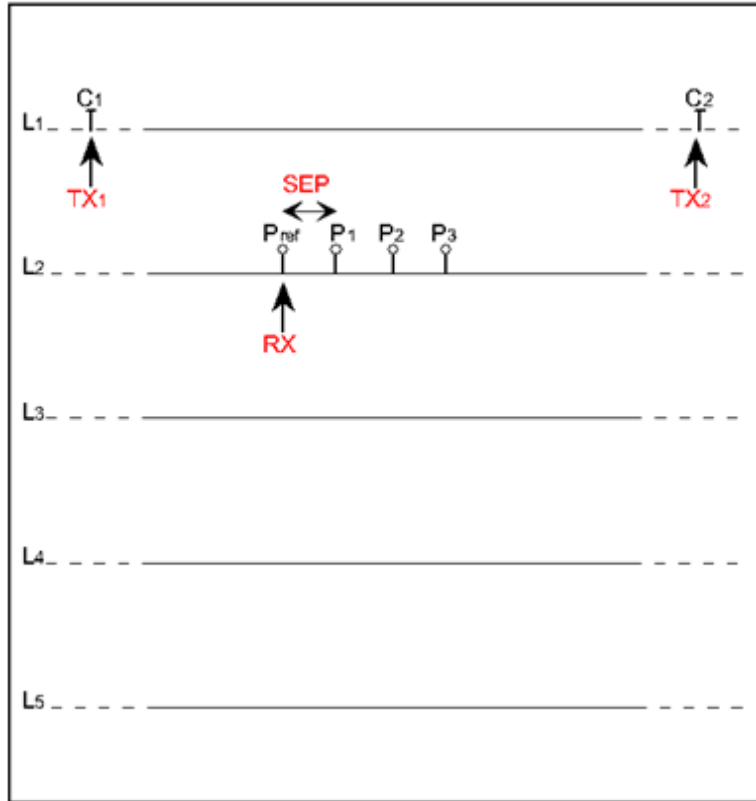

Gradient (2/16)

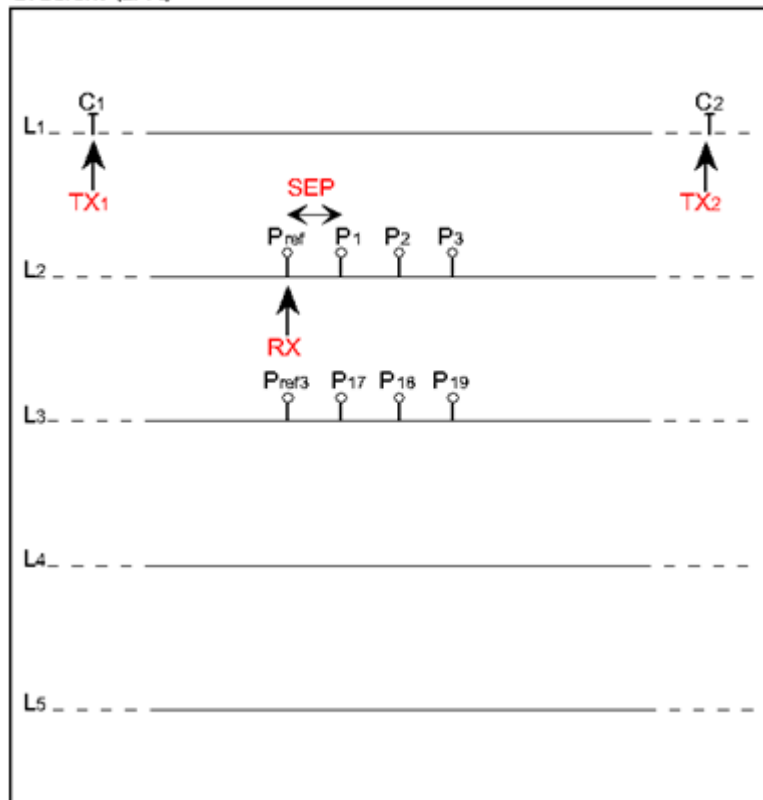

Gradient (4/8)

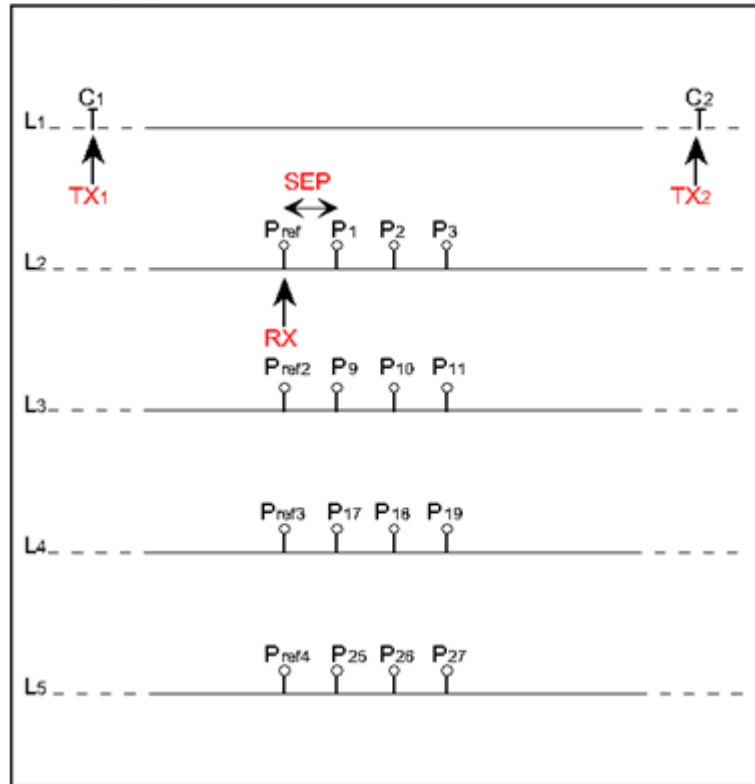

The electrodes C1 and C2 are fixed. The electrode P is moved parallel to C inside a zone located in the central part of C1, C2.

Wenner

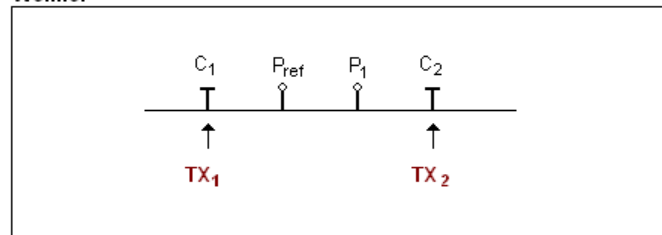

The electrodes C1, Pref, P1 and C2 are equidistant.

Schlumberger

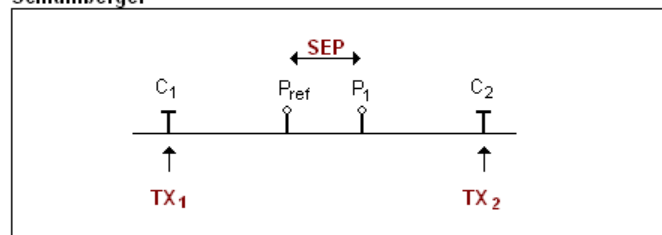

The electrodes Pref and P1 are located at the middle point of electrodes C1 and C2.

Annex 2 – 3D Survey

1. Receiver Dipole (1/32)

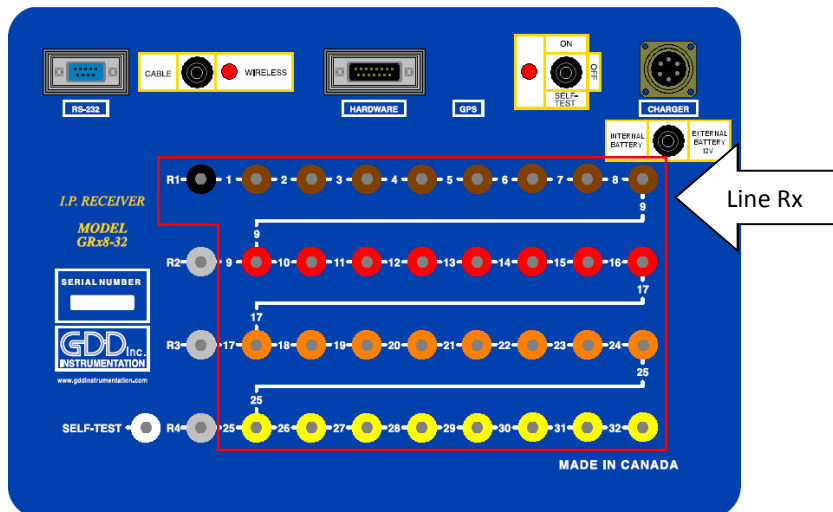

Electrode number (software parameter)	Electrode position on the receiver	Electrode color on the receiver	Electrode line number (software parameter)
PR1	1 st row – 1 st hole	Black	Line Rx
P1	1 st row – 2 nd hole	Brown	Line Rx
P2	1 st row – 3 rd hole	Brown	Line Rx
P3	1 st row – 4 th hole	Brown	Line Rx
P4	1 st row – 5 th hole	Brown	Line Rx
P5	1 st row – 6 th hole	Brown	Line Rx
P6	1 st row – 7 th hole	Brown	Line Rx
P7	1 st row – 8 th hole	Brown	Line Rx
P8	1 st row – 9 th hole	Brown	Line Rx
P9	2 nd row – 2 nd hole	Red	Line Rx
P10	2 nd row – 3 rd hole	Red	Line Rx
P11	2 nd row – 4 th hole	Red	Line Rx
P12	2 nd row – 5 th hole	Red	Line Rx
P13	2 nd row – 6 th hole	Red	Line Rx
P14	2 nd row – 7 th hole	Red	Line Rx
P15	2 nd row – 8 th hole	Red	Line Rx
P16	2 nd row – 9 th hole	Red	Line Rx
P17	3 rd row – 2 nd hole	Orange	Line Rx
P18	3 rd row – 3 rd hole	Orange	Line Rx
P19	3 rd row – 4 th hole	Orange	Line Rx
P20	3 rd row – 5 th hole	Orange	Line Rx
P21	3 rd row – 6 th hole	Orange	Line Rx
P22	3 rd row – 7 th hole	Orange	Line Rx
P23	3 rd row – 8 th hole	Orange	Line Rx
P24	3 rd row – 9 th hole	Orange	Line Rx
P25	4 th row – 3 rd hole	Yellow	Line Rx
P26	4 th row – 4 th hole	Yellow	Line Rx
P27	4 th row – 5 th hole	Yellow	Line Rx
P28	4 th row – 6 th hole	Yellow	Line Rx
P29	4 th row – 7 th hole	Yellow	Line Rx
P30	4 th row – 8 th hole	Yellow	Line Rx
P31	4 th row – 9 th hole	Yellow	Line Rx
P32	4 th row – 10 th hole	Yellow	Line Rx

Dipole number	Dipole description
D1	P1-PR1
D2	P2-P1
D3	P3-P2
D4	P4-P3
D5	P5-P4
D6	P6-P5
D7	P7-P6
D8	P8-P7
D9	P9-P8
D10	P10-P9
D11	P11-P10
D12	P12-P11
D13	P13-P12
D14	P14-P13
D15	P15-P14
D16	P16-P15
D17	P17-P16
D18	P18-P17
D19	P19-P18
D20	P20-P19
D21	P21-P20
D22	P22-P21
D23	P23-P22
D24	P24-P23
D25	P25-P24
D26	P26-P25
D27	P27-P26
D28	P28-P27
D29	P29-P28
D30	P30-P29
D31	P31-P30
D32	P32-P31

GDD software – Position parameters – Page 1

Position

LTx Line Tx 1 P1 5 P5

LRx Line Rx 2 P2 6 P6

Tx1 C1 3 P3 7 P7

Tx2 C2 4 P4 8 P8

Ref PR1 >>>> Page 2

Tx NEXT PREV. NEXT PREV. OK
 Rx STN STN LINE LINE

Start [Taskbar icons] 6:26 AM

GDD software – Position parameters – Page 2

Position

LTx Line Tx 9 P9 13 P13

LRx Line Rx 10 P10 14 P14

Tx1 C1 11 P11 15 P15

Tx2 C2 12 P12 16 P16

Ref PR1 >>>> Page 3

Tx NEXT PREV. NEXT PREV. OK
 Rx STN STN LINE LINE

Start [Taskbar icons] 6:26 AM

GDD software – Position parameters – Page 3

Position

LTx Line Tx 17 P17 21 P21

LRx Line Rx 18 P18 22 P22

Tx1 C1 19 P19 23 P23

Tx2 C2 20 P20 24 P24

Ref PR1 >>>> Page 4

Tx NEXT PREV. NEXT PREV. OK
 Rx STN STN LINE LINE

Start [Taskbar icons] 6:26 AM

GDD software – Position parameters – Page 4

Position

LTx Line Tx 25 P25 29 P29

LRx Line Rx 26 P26 30 P30

Tx1 C1 27 P27 31 P31

Tx2 C2 28 P28 32 P32

Ref PR1 >>>> Page 1

Tx NEXT PREV. NEXT PREV. OK
 Rx STN STN LINE LINE

Start [Taskbar icons] 6:26 AM

Pole-Dipole (1/32)

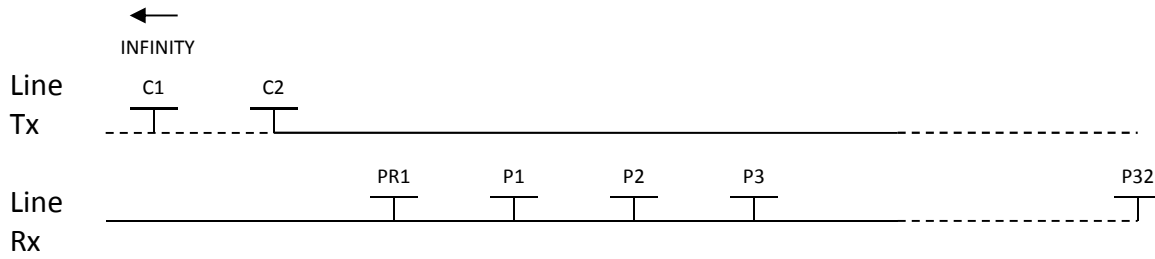

Dipole-Dipole (1/32)

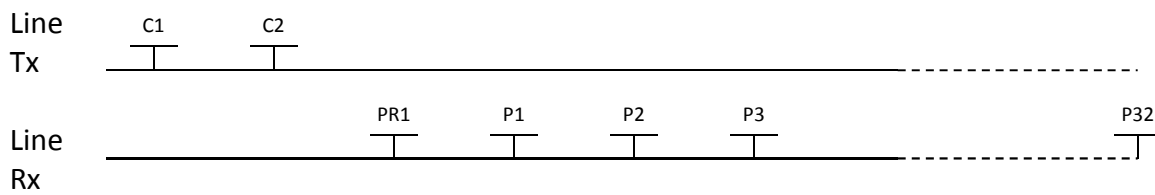

Gradient (1/32)

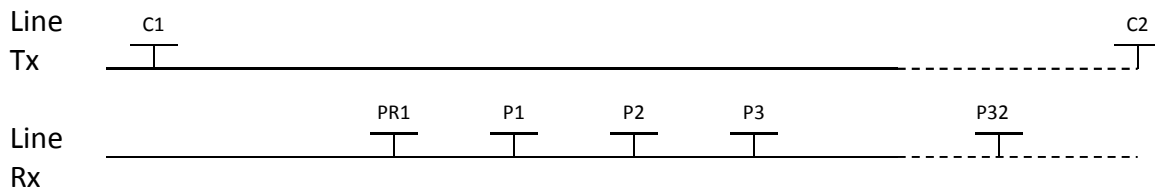

*The transmitter and the receiver can be on the same line.

2. Receiver Dipole (2/16)

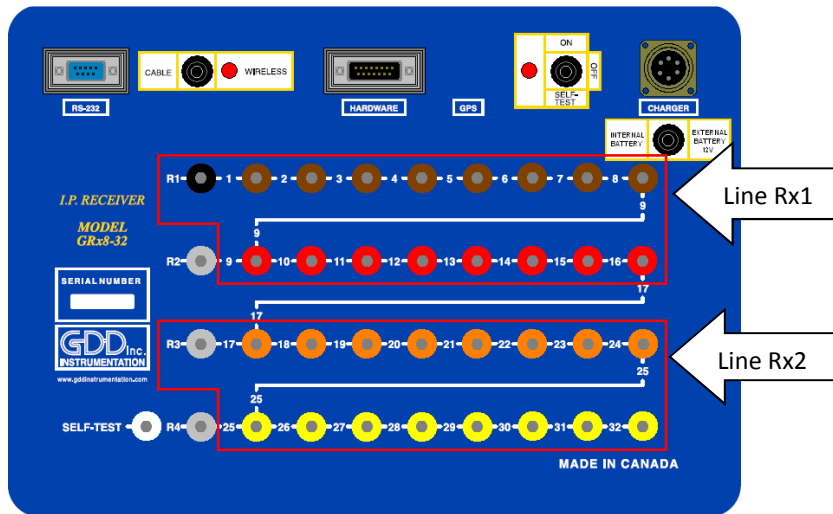

Electrode number (software parameter)	Electrode position on the receiver	Electrode color on the receiver	Electrode line number (software parameter)
PR1	1 st row – 1 st hole	Black	Line Rx1
P1	1 st row – 2 nd hole	Brown	Line Rx1
P2	1 st row – 3 rd hole	Brown	Line Rx1
P3	1 st row – 4 th hole	Brown	Line Rx1
P4	1 st row – 5 th hole	Brown	Line Rx1
P5	1 st row – 6 th hole	Brown	Line Rx1
P6	1 st row – 7 th hole	Brown	Line Rx1
P7	1 st row – 8 th hole	Brown	Line Rx1
P8	1 st row – 9 th hole	Brown	Line Rx1
P9	2 nd row – 2 nd hole	Red	Line Rx1
P10	2 nd row – 3 rd hole	Red	Line Rx1
P11	2 nd row – 4 th hole	Red	Line Rx1
P12	2 nd row – 5 th hole	Red	Line Rx1
P13	2 nd row – 6 th hole	Red	Line Rx1
P14	2 nd row – 7 th hole	Red	Line Rx1
P15	2 nd row – 8 th hole	Red	Line Rx1
P16	2 nd row – 9 th hole	Red	Line Rx1
PR3	3 rd row – 1 st hole	Grey	Line Rx2
P17	3 rd row – 2 nd hole	Orange	Line Rx2
P18	3 rd row – 3 rd hole	Orange	Line Rx2
P19	3 rd row – 4 th hole	Orange	Line Rx2
P20	3 rd row – 5 th hole	Orange	Line Rx2
P21	3 rd row – 6 th hole	Orange	Line Rx2
P22	3 rd row – 7 th hole	Orange	Line Rx2
P23	3 rd row – 8 th hole	Orange	Line Rx2
P24	3 rd row – 9 th hole	Orange	Line Rx2
P25	4 th row – 3 rd hole	Yellow	Line Rx2
P26	4 th row – 4 th hole	Yellow	Line Rx2
P27	4 th row – 5 th hole	Yellow	Line Rx2
P28	4 th row – 6 th hole	Yellow	Line Rx2
P29	4 th row – 7 th hole	Yellow	Line Rx2
P30	4 th row – 8 th hole	Yellow	Line Rx2
P31	4 th row – 9 th hole	Yellow	Line Rx2
P32	4 th row – 10 th hole	Yellow	Line Rx2

Dipole number	Dipole description
D1	P1-PR1
D2	P2-P1
D3	P3-P2
D4	P4-P3
D5	P5-P4
D6	P6-P5
D7	P7-P6
D8	P8-P7
D9	P9-P8
D10	P10-P9
D11	P11-P10
D12	P12-P11
D13	P13-P12
D14	P14-P13
D15	P15-P14
D16	P16-P15
D17	P17-PR3
D18	P18-P17
D19	P19-P18
D20	P20-P19
D21	P21-P20
D22	P22-P21
D23	P23-P22
D24	P24-P23
D25	P25-P24
D26	P26-P25
D27	P27-P26
D28	P28-P27
D29	P29-P28
D30	P30-P29
D31	P31-P30
D32	P32-P31

GDD software – Position parameters – Page 1

GDD software – Position parameters – Page 2

GDD software – Position parameters – Page 3

GDD software – Position parameters – Page 4

Pole-Dipole (2/16)

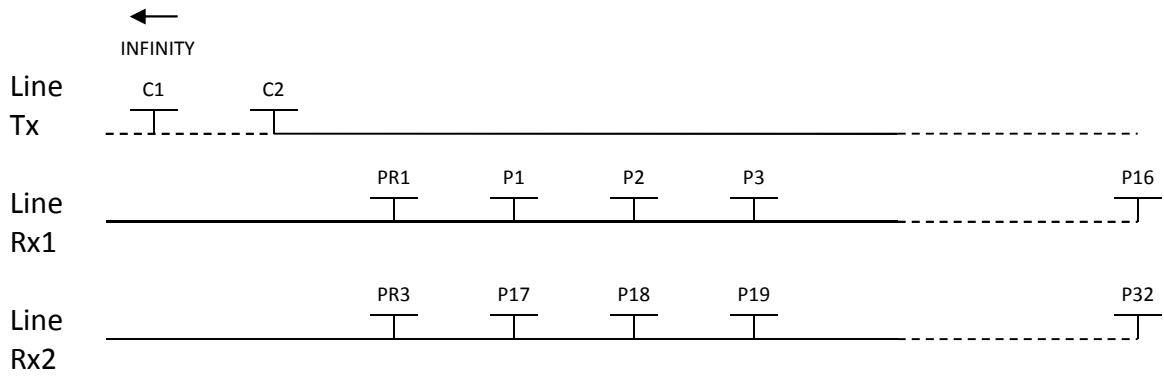

Dipole-Dipole (2/16)

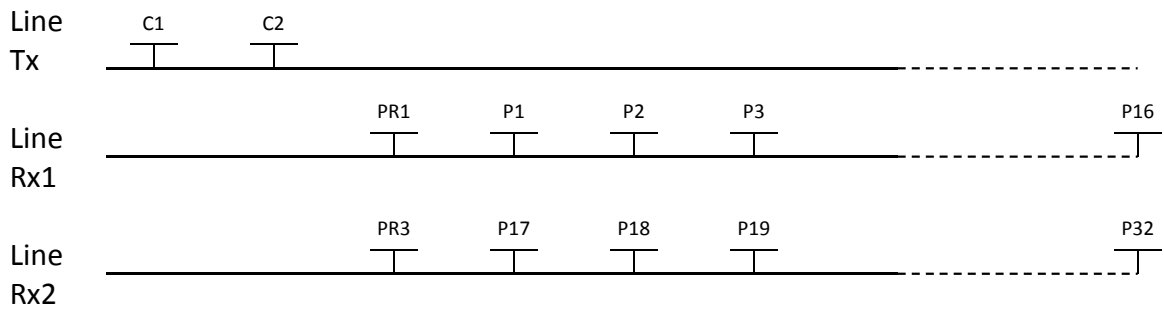

Gradient (2/16)

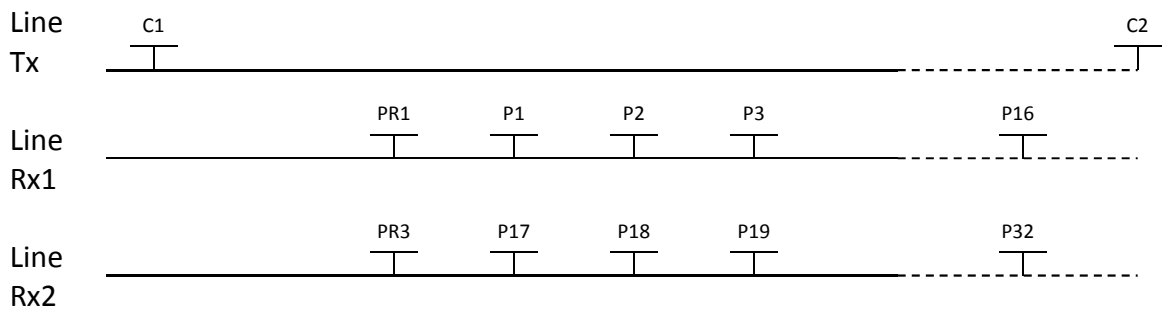

*The transmitter and the receiver can be on the same line.

3. Receiver Dipole (4/8)

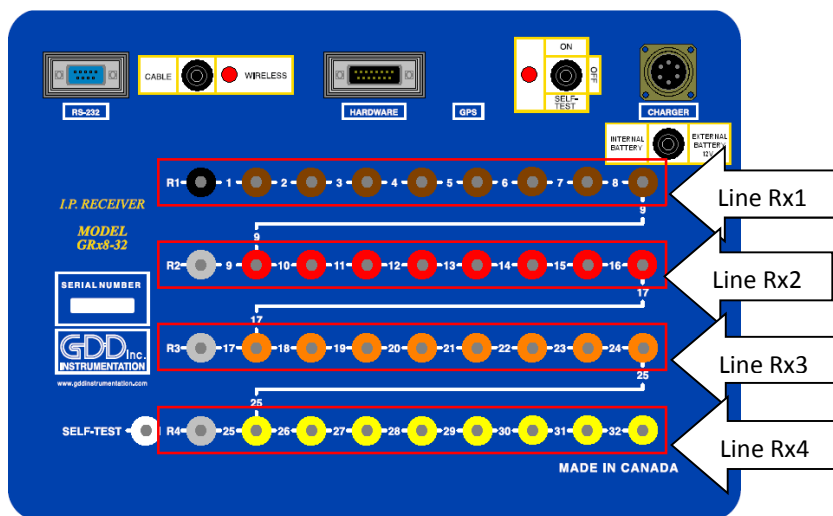

Electrode number (software parameter)	Electrode position on the receiver	Electrode color on the receiver	Electrode line number (software parameter)
PR1	1 st row – 1 st hole	Black	Line Rx1
P1	1 st row – 2 nd hole	Brown	Line Rx1
P2	1 st row – 3 rd hole	Brown	Line Rx1
P3	1 st row – 4 th hole	Brown	Line Rx1
P4	1 st row – 5 th hole	Brown	Line Rx1
P5	1 st row – 6 th hole	Brown	Line Rx1
P6	1 st row – 7 th hole	Brown	Line Rx1
P7	1 st row – 8 th hole	Brown	Line Rx1
P8	1 st row – 9 th hole	Brown	Line Rx1
PR2	2 nd row – 1 st hole	Grey	Line Rx2
P9	2 nd row – 2 nd hole	Red	Line Rx2
P10	2 nd row – 3 rd hole	Red	Line Rx2
P11	2 nd row – 4 th hole	Red	Line Rx2
P12	2 nd row – 5 th hole	Red	Line Rx2
P13	2 nd row – 6 th hole	Red	Line Rx2
P14	2 nd row – 7 th hole	Red	Line Rx2
P15	2 nd row – 8 th hole	Red	Line Rx2
P16	2 nd row – 9 th hole	Red	Line Rx2
PR3	3 rd row – 1 st hole	Grey	Line Rx3
P17	3 rd row – 2 nd hole	Orange	Line Rx3
P18	3 rd row – 3 rd hole	Orange	Line Rx3
P19	3 rd row – 4 th hole	Orange	Line Rx3
P20	3 rd row – 5 th hole	Orange	Line Rx3
P21	3 rd row – 6 th hole	Orange	Line Rx3
P22	3 rd row – 7 th hole	Orange	Line Rx3
P23	3 rd row – 8 th hole	Orange	Line Rx3
P24	3 rd row – 9 th hole	Orange	Line Rx3
PR4	4 th row – 2 nd hole	Grey	Line Rx4
P25	4 th row – 3 rd hole	Yellow	Line Rx4
P26	4 th row – 4 th hole	Yellow	Line Rx4
P27	4 th row – 5 th hole	Yellow	Line Rx4
P28	4 th row – 6 th hole	Yellow	Line Rx4
P29	4 th row – 7 th hole	Yellow	Line Rx4
P30	4 th row – 8 th hole	Yellow	Line Rx4
P31	4 th row – 9 th hole	Yellow	Line Rx4
P32	4 th row – 10 th hole	Yellow	Line Rx4

Dipole number	Dipole description
D1	P1-PR1
D2	P2-P1
D3	P3-P2
D4	P4-P3
D5	P5-P4
D6	P6-P5
D7	P7-P6
D8	P8-P7
D9	P9-PR2
D10	P10-P9
D11	P11-P10
D12	P12-P11
D13	P13-P12
D14	P14-P13
D15	P15-P14
D16	P16-P15
D17	P17-PR3
D18	P18-P17
D19	P19-P18
D20	P20-P19
D21	P21-P20
D22	P22-P21
D23	P23-P22
D24	P24-P23
D25	P25-PR4
D26	P26-P25
D27	P27-P26
D28	P28-P27
D29	P29-P28
D30	P30-P29
D31	P31-P30
D32	P32-P31

GDD software – Position parameters – Page 1

GDD software – Position parameters – Page 2

Position

LTx	Line Tx	1	P1	5	P5
LR1	Line Rx1	2	P2	6	P6
Tx1	C1	3	P3	7	P7
Tx2	C2	4	P4	8	P8
Rf1	PR1	>>>> Page 2			

Tx NEXT PREV. NEXT PREV.
 Rx STN STN LINE LINE OK

Start | 100 PC | 6:27 AM

Position

LTx	Line Tx	9	P9	13	P13
LR2	Line Rx2	10	P10	14	P14
Tx1	C1	11	P11	15	P15
Tx2	C2	12	P12	16	P16
Rf2	PR2	>>>> Page 3			

Tx NEXT PREV. NEXT PREV.
 Rx STN STN LINE LINE OK

Start | 100 PC | 6:28 AM

GDD software – Position parameters – Page 3

GDD software – Position parameters – Page 4

Position

LTx	Line Tx	17	P17	21	P21
LR3	Line Rx3	18	P18	22	P22
Tx1	C1	19	P19	23	P23
Tx2	C2	20	P20	24	P24
Rf3	PR3	>>>> Page 4			

Tx NEXT PREV. NEXT PREV.
 Rx STN STN LINE LINE OK

Start | 100 PC | 6:28 AM

Position

LTx	Line Tx	25	P25	29	P29
LR4	Line Rx4	26	P26	30	P30
Tx1	C1	27	P27	31	P31
Tx2	C2	28	P28	32	P32
Rf4	PR4	>>>> Page 1			

Tx NEXT PREV. NEXT PREV.
 Rx STN STN LINE LINE OK

Start | 100 PC | 6:28 AM

Pole-Dipole (4/8)

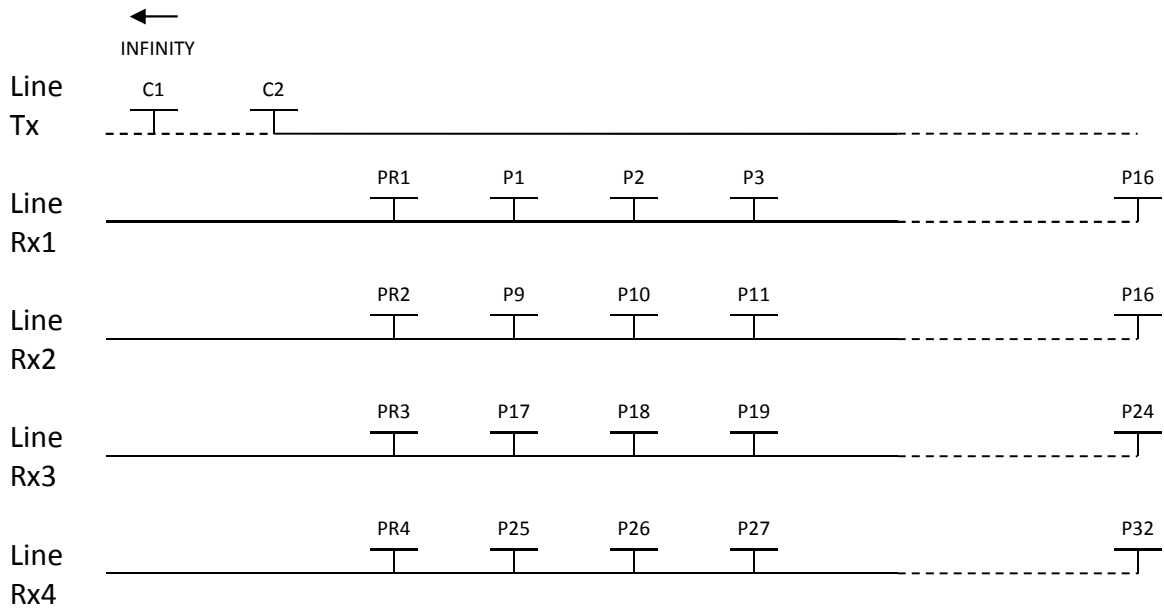

Dipole-Dipole (4/8)

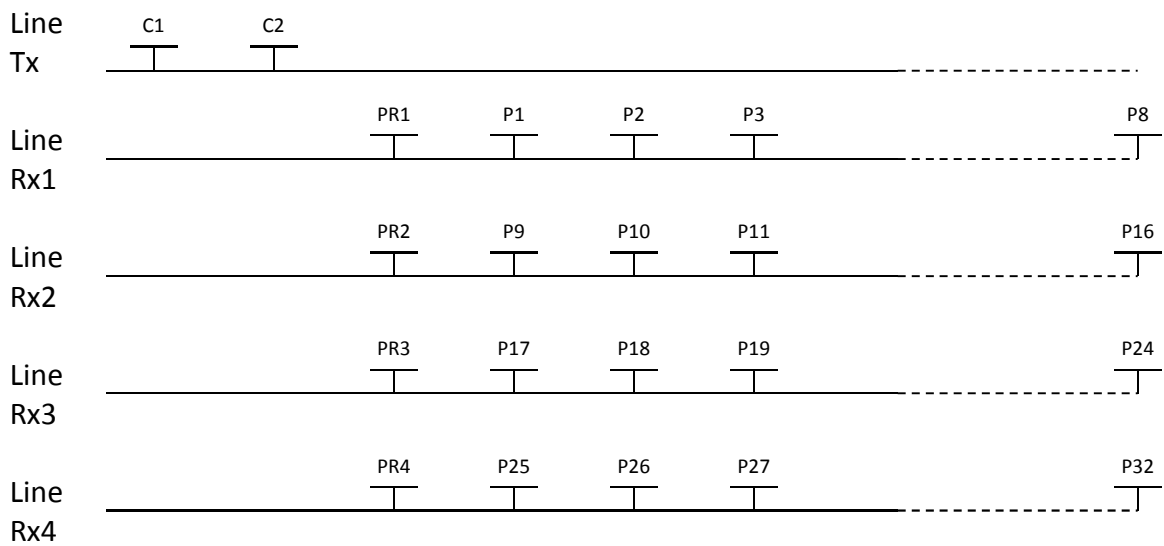

Gradient (4/8)

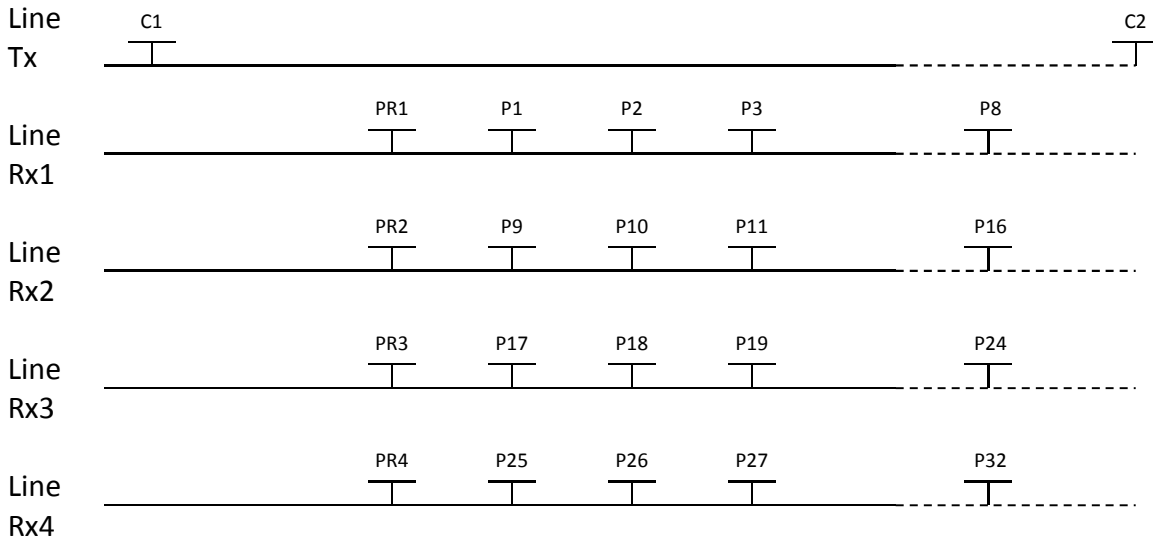

*The transmitter and the receiver can be on the same line.

4. Receiver Dipole (2/4) – For GRx8mini model only

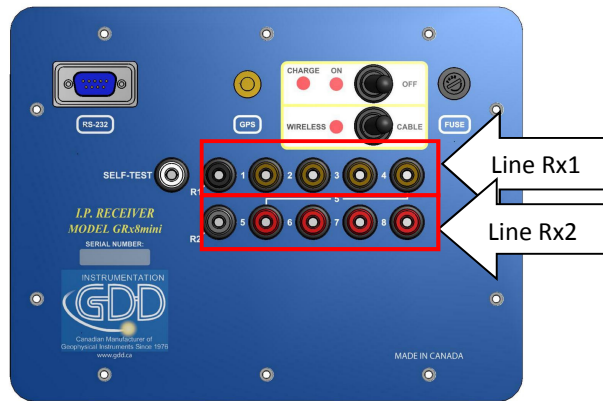

Electrode number (software parameter)	Electrode position on the receiver	Electrode color on the receiver	Electrode line number (software parameter)
PR1	1 st row – 1 st hole	Black	Line Rx1
P1	1 st row – 2 nd hole	Brown	Line Rx1
P2	1 st row – 3 rd hole	Brown	Line Rx1
P3	1 st row – 4 th hole	Brown	Line Rx1
P4	1 st row – 5 th hole	Brown	Line Rx1
PR2	2 nd row – 1 st hole	Grey	Line Rx2
P5	2 nd row – 2 nd hole	Red	Line Rx2
P6	2 nd row – 3 rd hole	Red	Line Rx2
P7	2 nd row – 4 th hole	Red	Line Rx2
P8	2 nd row – 5 th hole	Red	Line Rx2

Dipole number	Dipole description
D1	P1-PR1
D2	P2-P1
D3	P3-P2
D4	P4-P3
D5	P5-PR2
D6	P6-P5
D7	P7-P6
D8	P8-P7

GDD software – Position parameters – Page 1

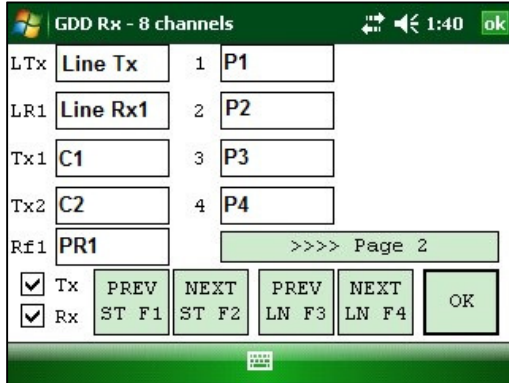

GDD software – Position parameters – Page 2

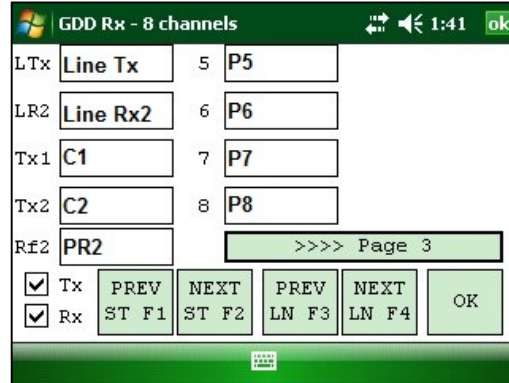

Pole-Dipole (2/4)

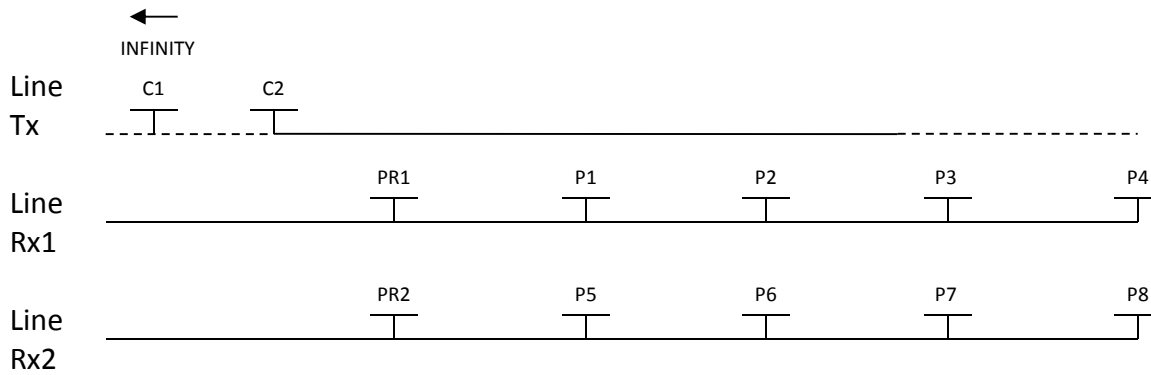

Dipole-Dipole (2/4)

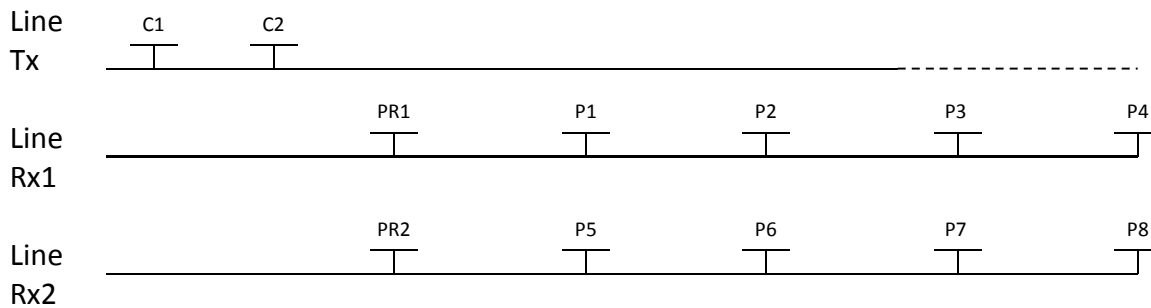

Gradient (2/4)

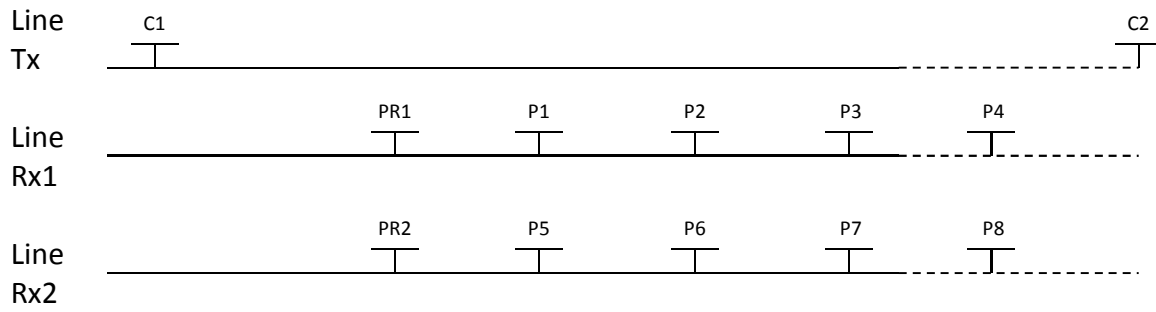

*The transmitter and the receiver can be on the same line.

Annex 3 – Field survey setup

Survey setup

Line information

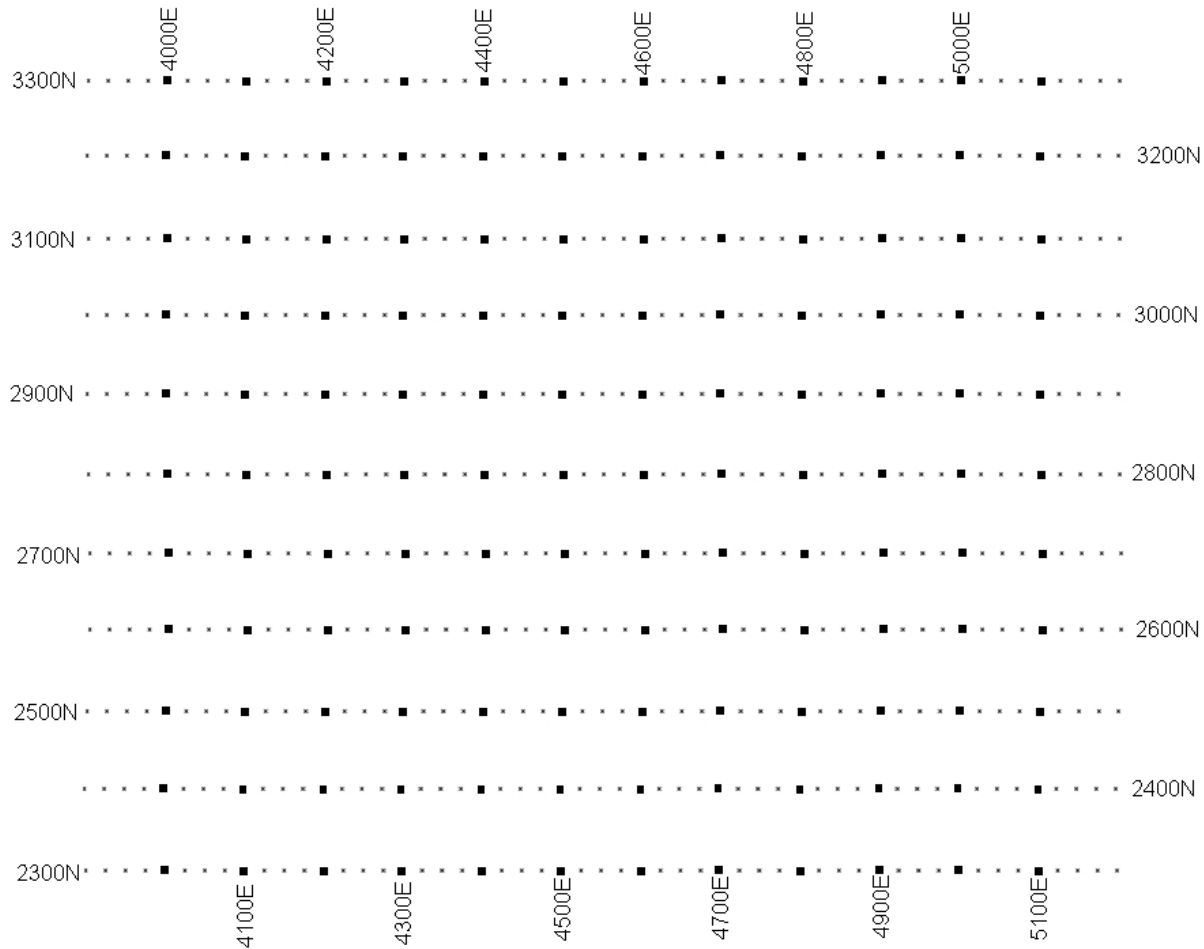

This survey consists of 11 lines, each separated by 100m. Each line is 1.3 km long. The examples below will begin at position 3300N-3900E.

Pole-Pole

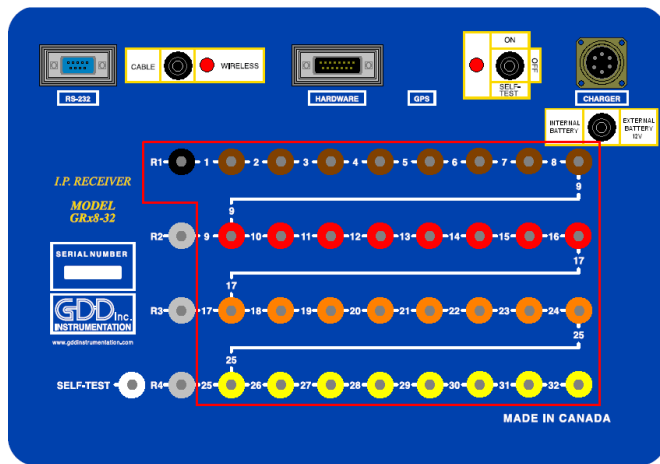
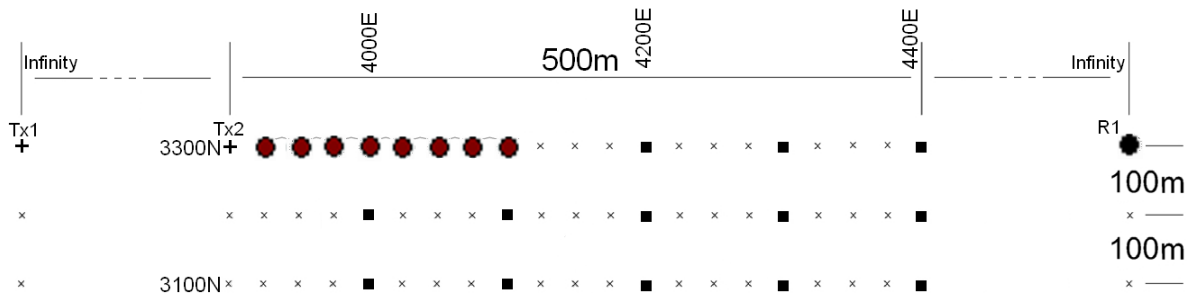

- Legend
- x Station
 - + Tx electrode
 - Rx electrode
 - R1 Reference electrode

For this pole-pole setup, 8 electrodes of the GDD-Rx will be used.

- 1) Select Pole-Pole in the setup page.

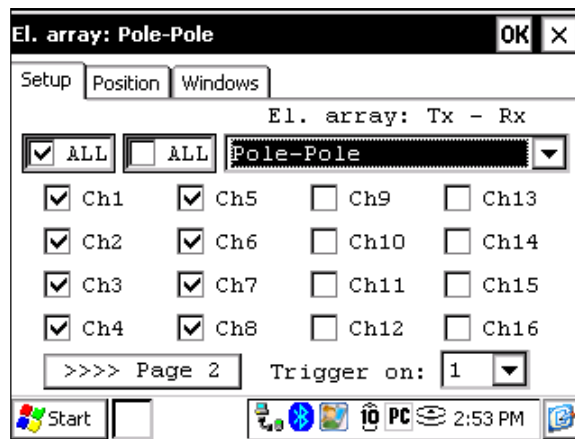

2) Enter the positions corresponding to your survey parameters.

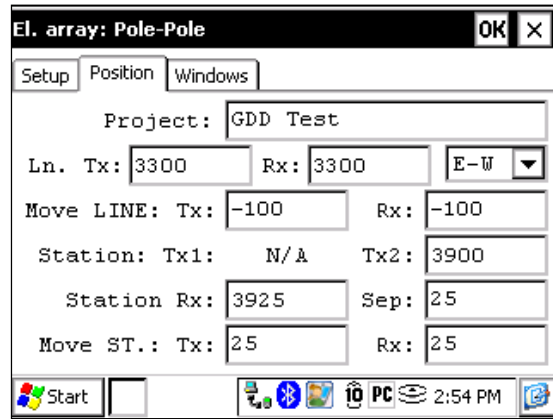

3) If all the values are correct, click the Ok button to continue and take a reading. If something is incorrect, you can modify it on this page.

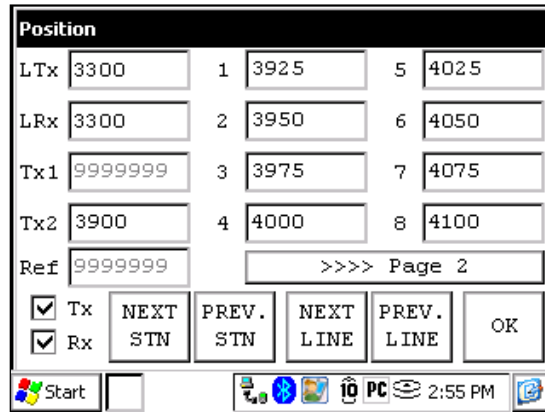

4) When the reading is done, click the NEXT STN button to increment the positions.

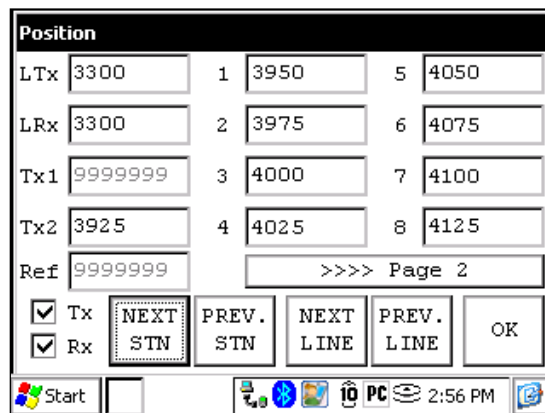

Pole-Dipole (1/32)

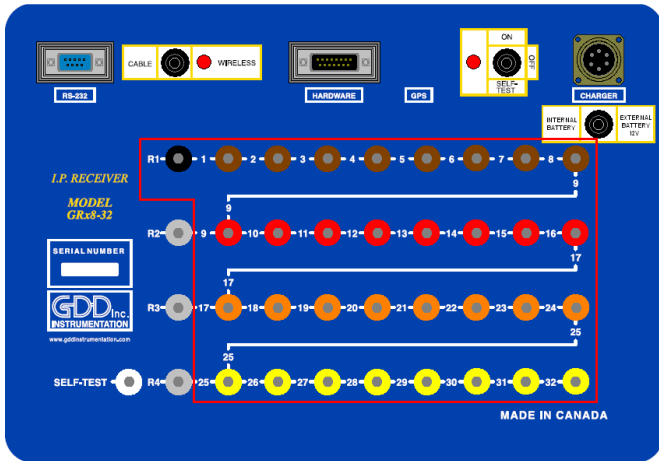
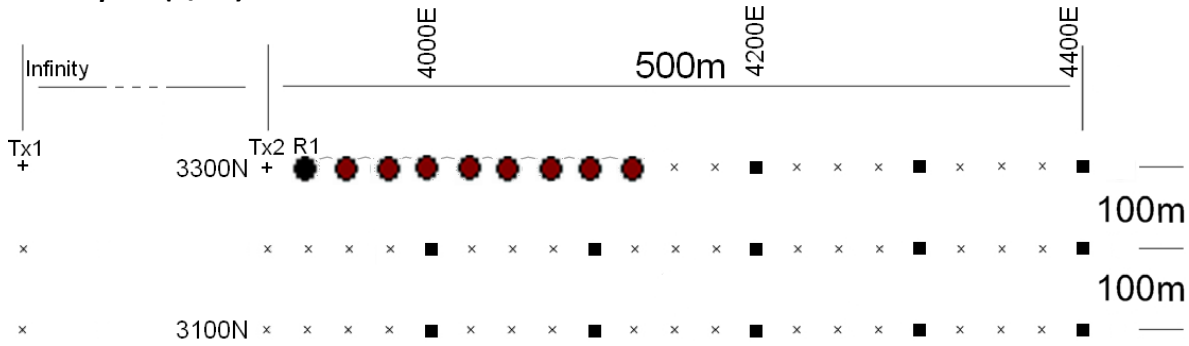

- Legend**
- x Station
 - + Tx electrode
 - Rx electrode
 - R1 Reference electrode

For this pole-dipole setup, 8 electrodes of the GDD-Rx will be used.

- 1) Select Pole-Dipole (1/32) in the setup page. The Pole-Dipole (2/16) and Pole-Dipole (4/8) options are explained in the 3D survey section at the end of this document.

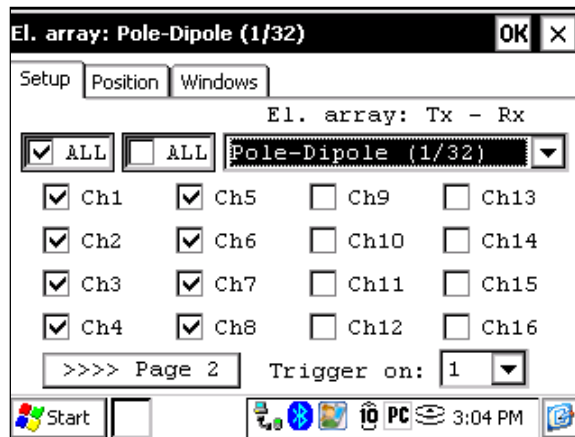



2) Enter the positions corresponding to your survey parameters.

3) If all the values are correct, click the Ok button to continue and take a reading. If something is incorrect, you can modify it on this page.

4) When the reading is done, click the NEXT STN button to increment the positions.

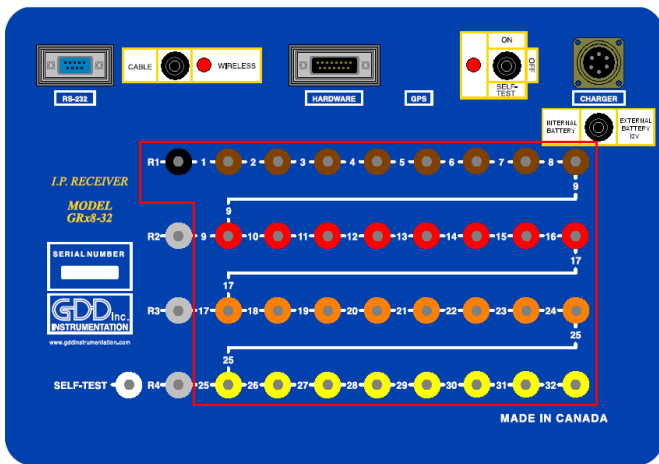
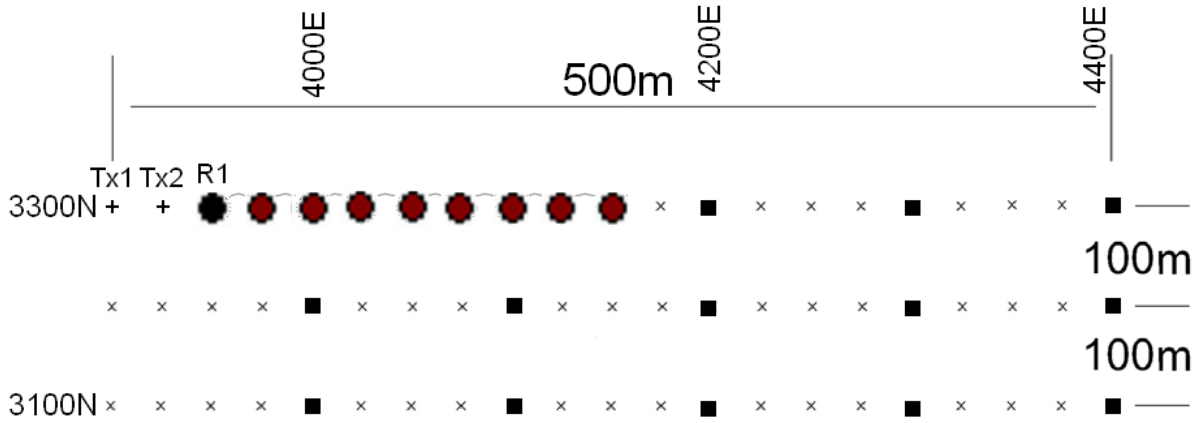
Dipole-Dipole (1/32)



- Legend**
- x Station
 - + Tx electrode
 -  Rx electrode
 - R1 Reference electrode

For this dipole-dipole setup, 8 electrodes of the GDD-Rx will be used.

- 1) Select Dipole-Dipole (1/32) in the setup page.

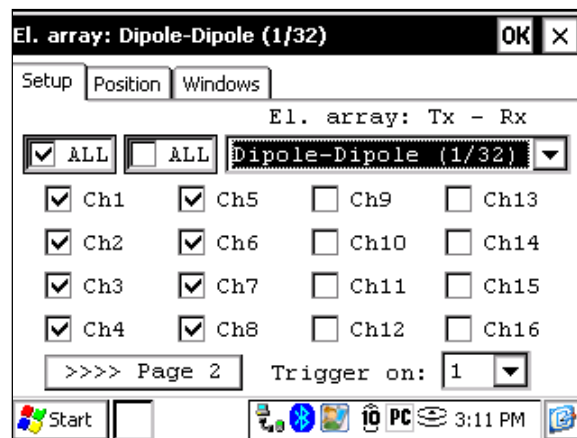

2) Enter the positions corresponding to your survey parameters.

3) If all the values are correct, click the Ok button to continue and take a reading. If something is incorrect, you can modify it on this page.

4) When the reading is done, click the NEXT STN button to increment the positions.

Gradient (1/32)

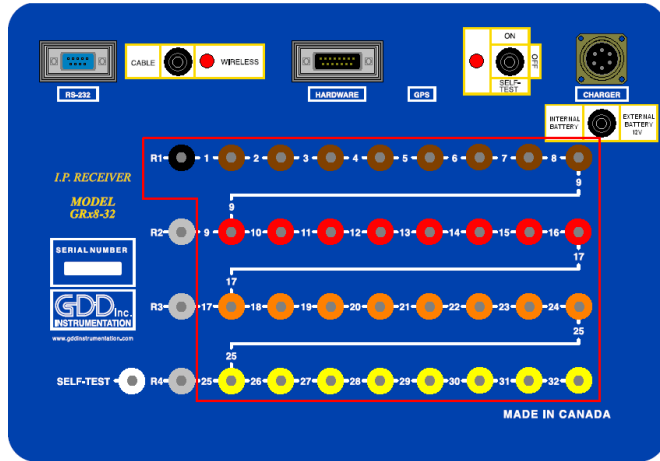
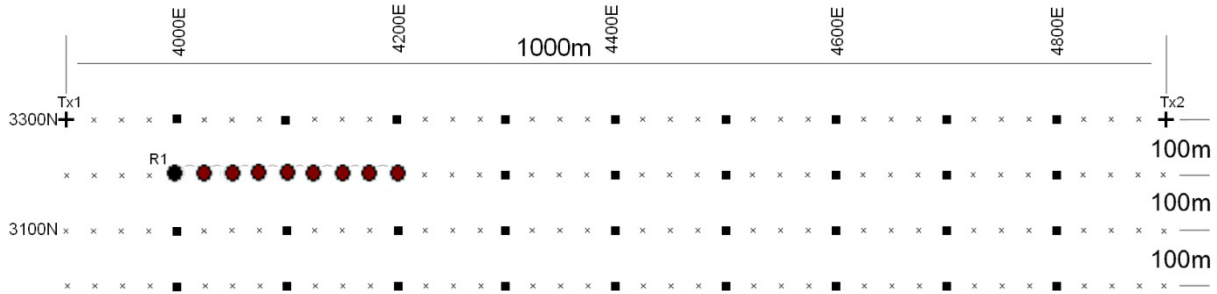

- Legend
- x Station
 - + Tx electrode
 - Rx electrode
 - R1 Reference electrode

For this Gradient setup, 8 electrodes of the GDD-Rx will be used.

- 1) Select Gradient (1/32) in the setup page.

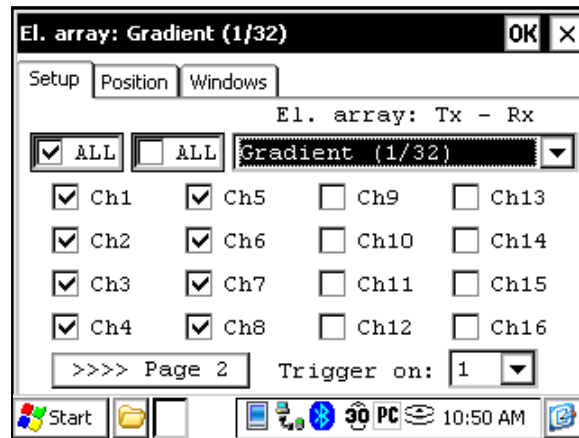

2) Enter the positions corresponding to your survey parameters.

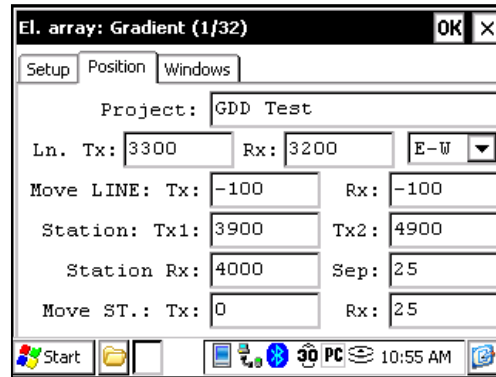

3) If all the values are correct, click the Ok button to continue and take a reading. If something is incorrect, you can modify it on this page. Uncheck the Tx box so that only the Receiver electrodes position will change.

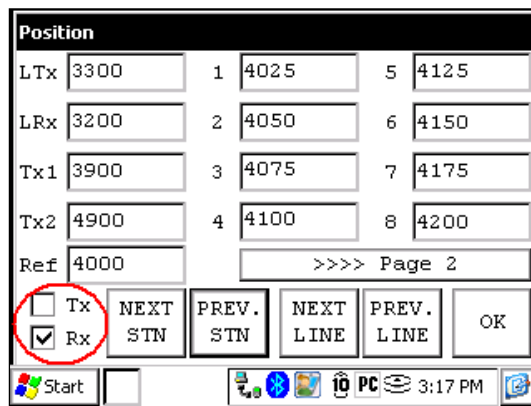

4) When the reading is done, make sure that the Tx box is unchecked, click the NEXT STN button to increment the positions. Only the Receiver electrodes position changes. In this example, you will need to click the NEXT STN button 8 times to be at the position indicated on the next screen.

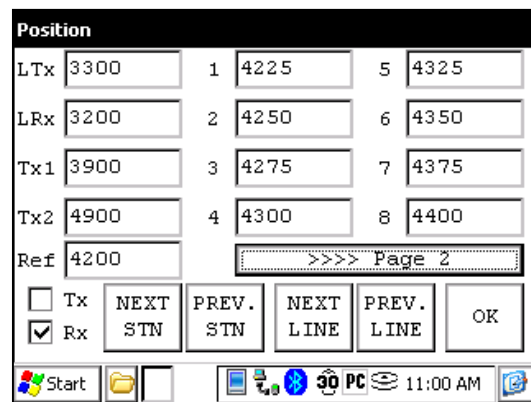

5) Your next setup on the field should be like this.

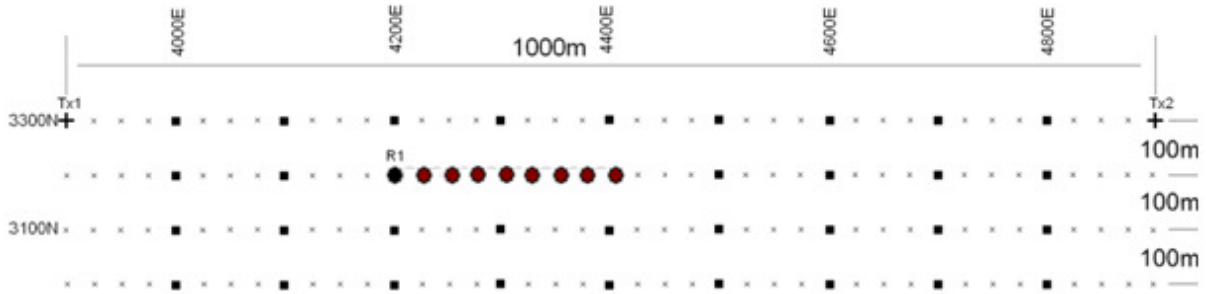

Wenner

A Wenner setup uses only two electrodes, the Reference R1 and the electrode 1 of the GDD Rx.

1) Select Wenner in the setup page and check only one channel.

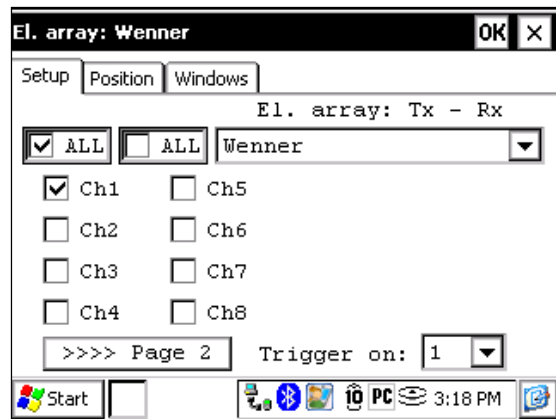

2) Enter the positions corresponding to your survey parameters.

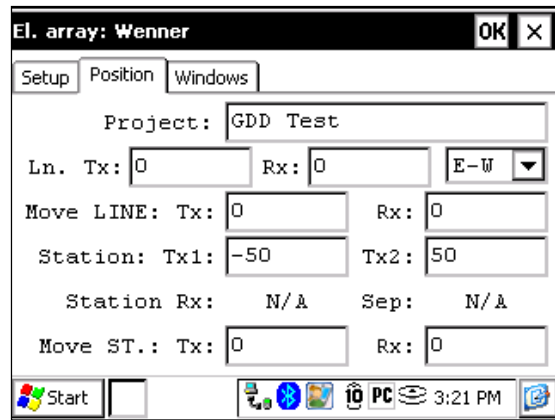

3) If all the values are correct, click the Ok button to continue and take a reading. If something is incorrect, you can modify it on this page.

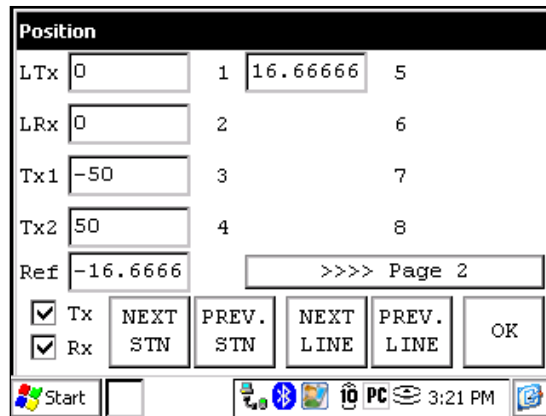

4) For a Wenner survey, you will have to manually enter the parameters for each reading. To access the Position page, click the Tools button and select the Config option in the pop-up menu.

Schlumberger

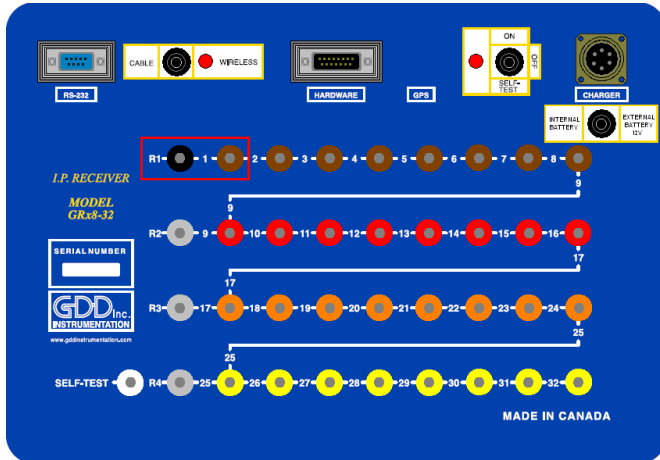
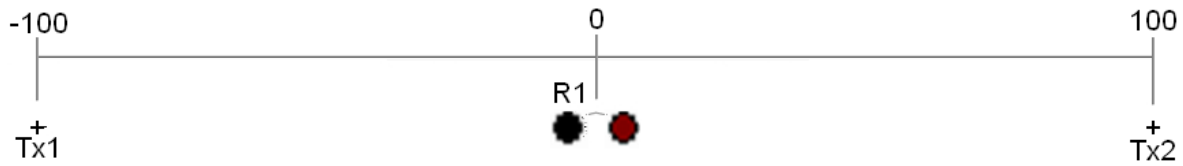

- Legend
- x Station
 - + Tx electrode
 - Rx electrode
 - R1 Reference electrode

A Schlumberger setup uses only the Reference R1 and the electrode 1 of the GDD Rx.

- 1) Select Schlumberger in the setup page.

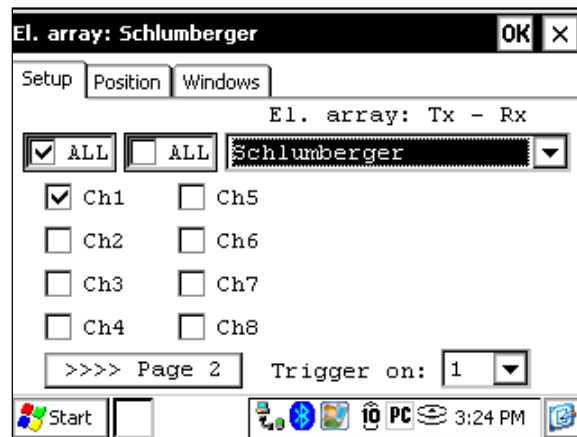

2) Enter the positions corresponding to your survey parameters.

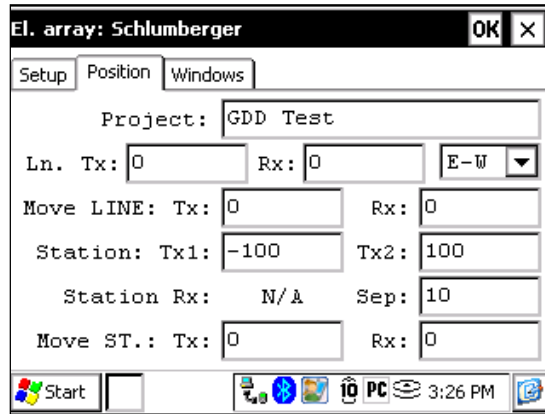

3) If all the values are correct, click the Ok button to continue and take a reading. If something is incorrect, you can modify it on this page.

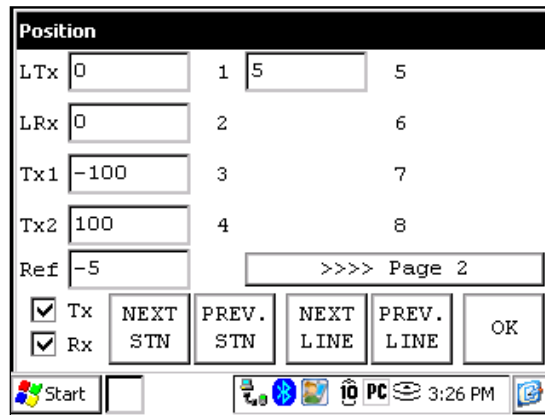

4) For a Schlumberger survey, you will have to manually enter the parameters for each reading. To access the Position page, click the Tools button and select the Config option in the pop-up menu.

3D Survey: Pole-Dipole (2/16)

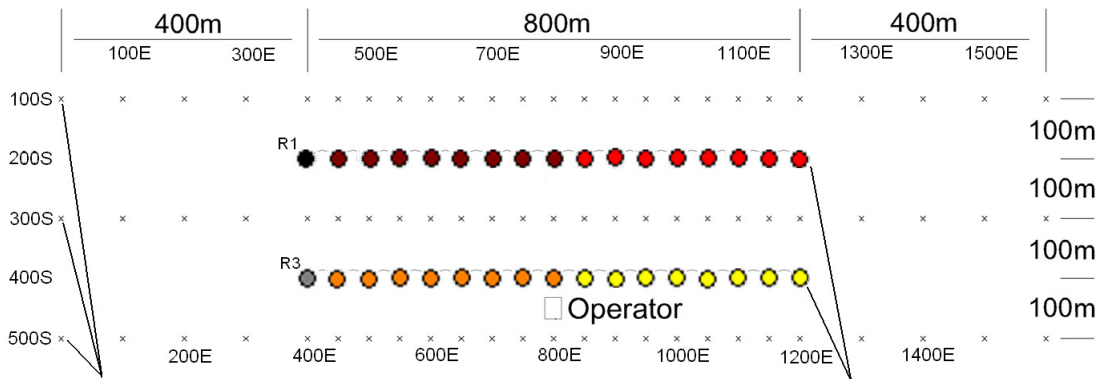

Transmitter pole electrodes
 3 lines of electrodes
 100m either side of the receiver line
 17 electrodes plus 4 at each end
 =25 per line x 3 lines
 =75 transmitter pole electrodes

Receiver electrodes
 2 lines
 17 electrodes per line
 16 dipoles per line
 Fixed location

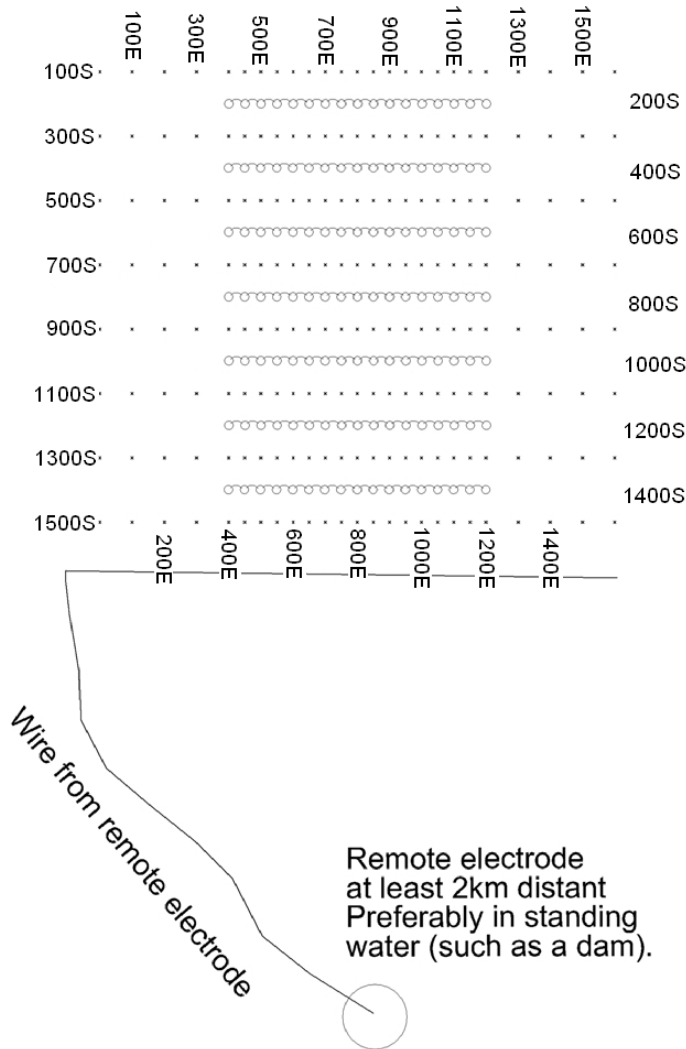

As shown on the images on the previous page, this setup is for 2 lines of 16 dipoles each using a GDD Rx-32. For the reference pins, R1 and R3 will be used; R2 and R4 will not be used since this is a 2 line setup.

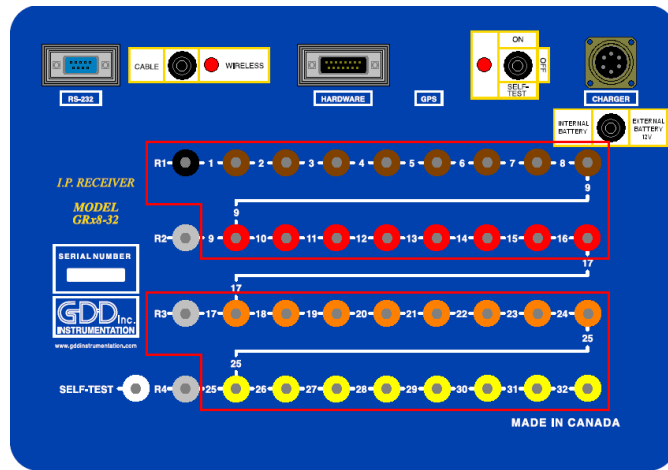

1) Select the Pole-Dipole 2/16 on the Setup tab.

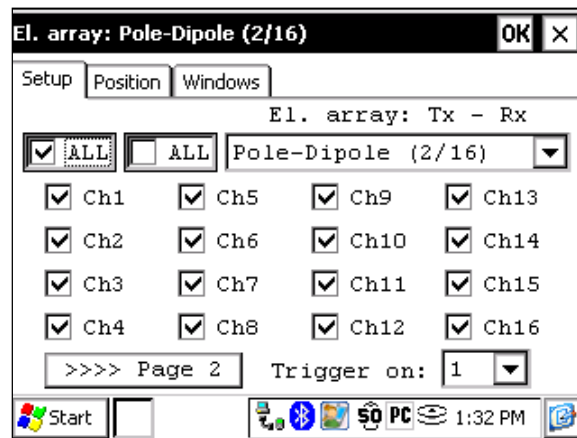

2) On the Position tab; enter the parameters of your survey.

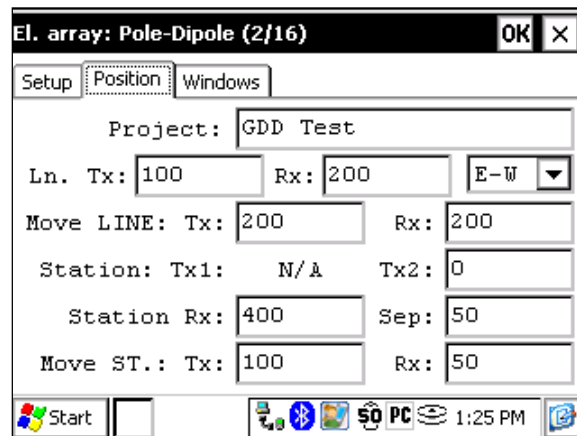

- 3) Uncheck the Rx box so that only the Tx position will change when you click the NEXT STN and NEXT LINE buttons. Verify that the positions of the 32 electrodes are set properly. Hit the OK button to close this window. On the next screen, click Start to take readings.

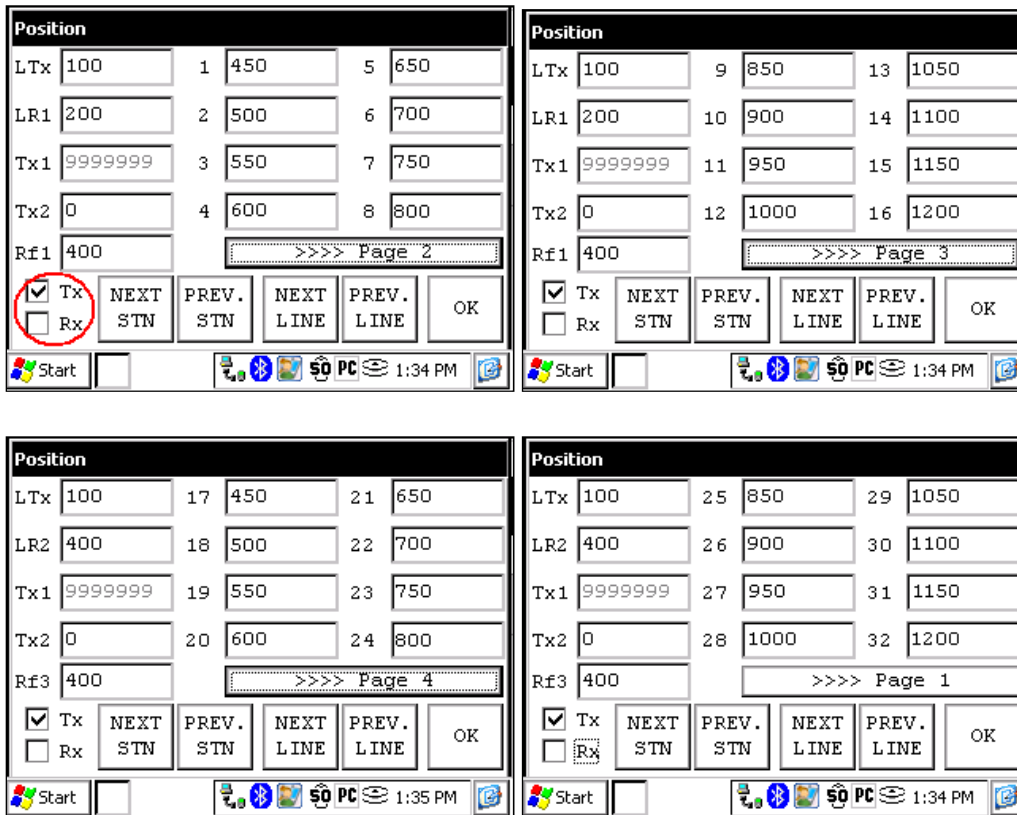

- 4) After readings are taken and stored, click the Start button. Click the NEXT STN button and only the Tx2 station will be incremented by 100 since it was entered as the Tx spacing.

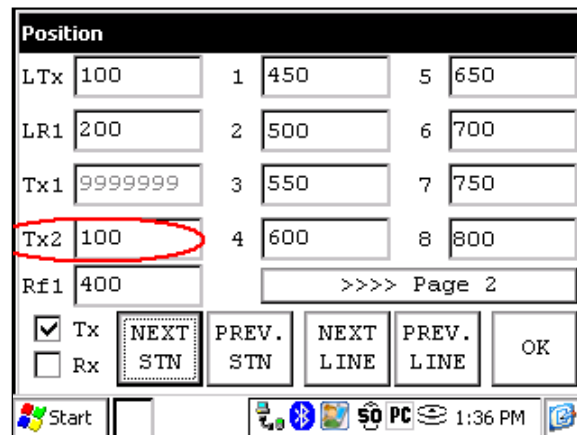

- 5) When the Tx2 station position is at 400, you will have to modify the spacing from 100 to 50. Select Tools -> Config and the next screen will appear. Select the Position tab and change the Move St.: TX: to 50.

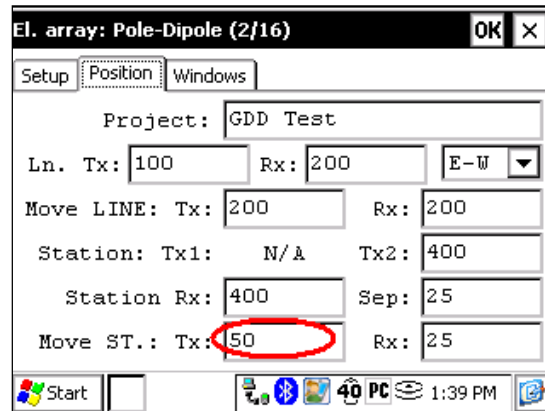

- 6) Continue the survey. When the Tx2 station position is at 1200, you will have to change the spacing back to 100.

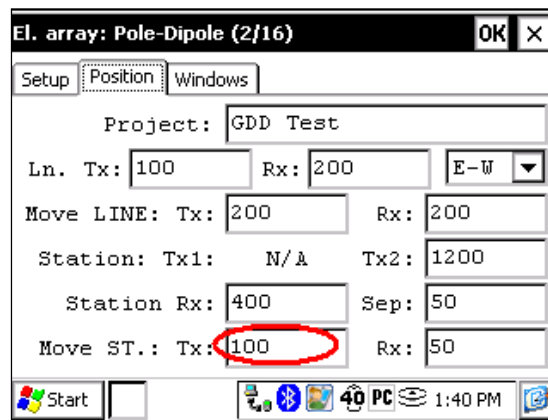

- 7) When the line is complete press NEXT LINE to increment the LTx.

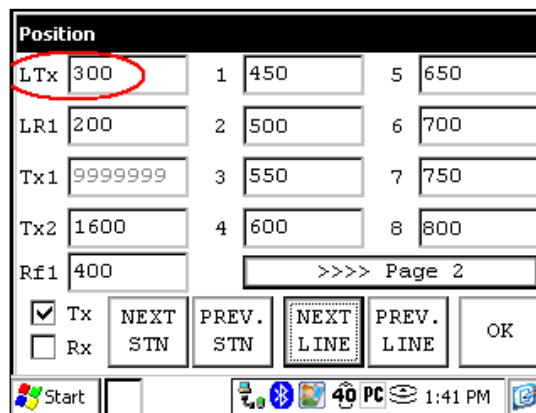

- 8) When the line is done, change the Move ST.: TX: to -100 or the Tx2 position to 0 depending on where you are starting the next line.

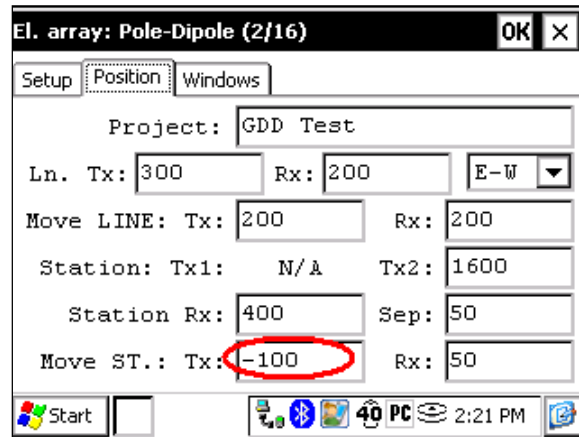

3D survey: Gradient (4/8)

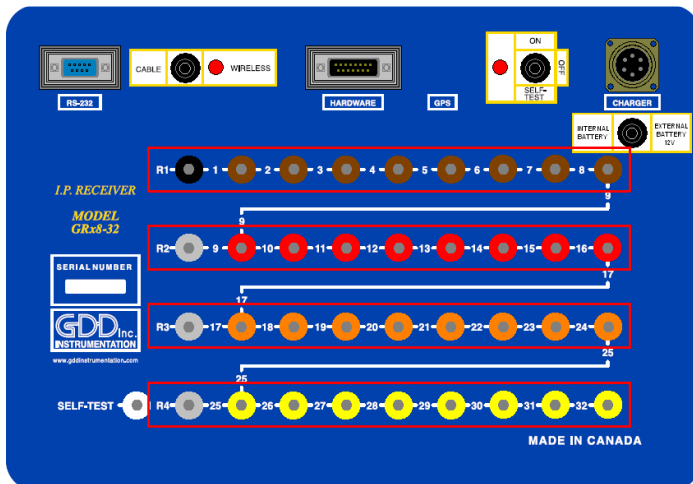
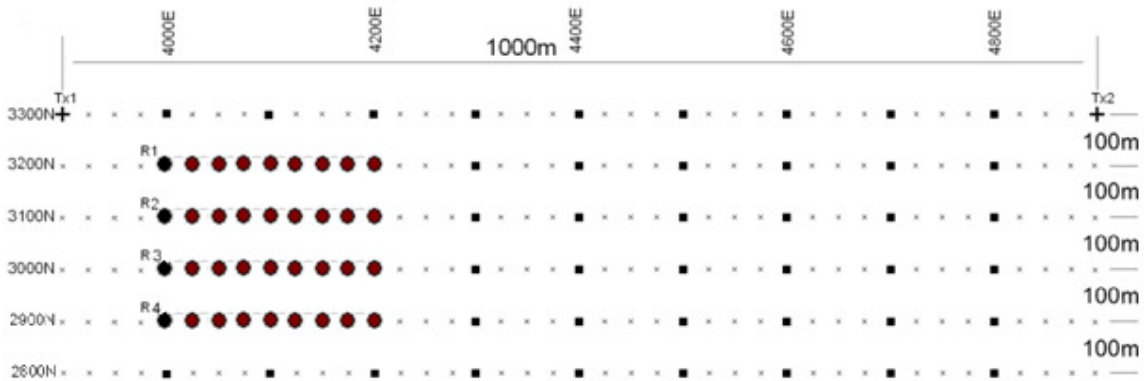

- Legend**
- x Station
 - + Tx electrode
 - Rx electrode
 - R1 Reference electrode

For this Gradient setup, 32 electrodes of the GDD-Rx will be used.

- 1) Select Gradient (4/8) in the setup page.

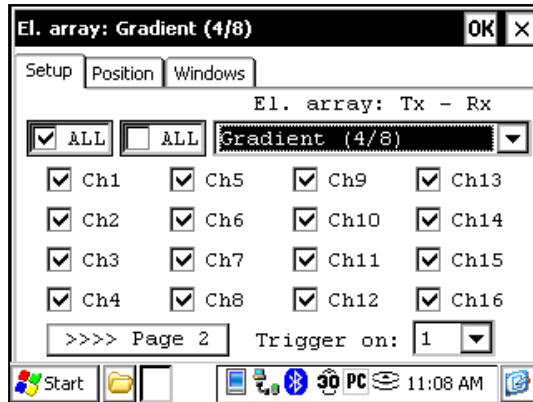

- 2) Enter the positions corresponding to your survey parameters.

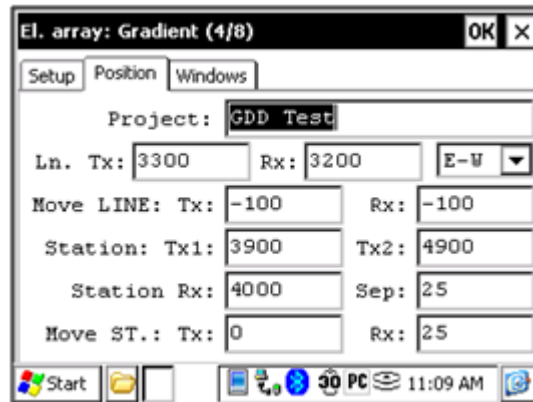

- 3) If all the values are correct, click the Ok button to continue and take a reading. If something is incorrect, you can modify it on these pages. Uncheck the Tx box so that only the Receiver electrodes position will change.

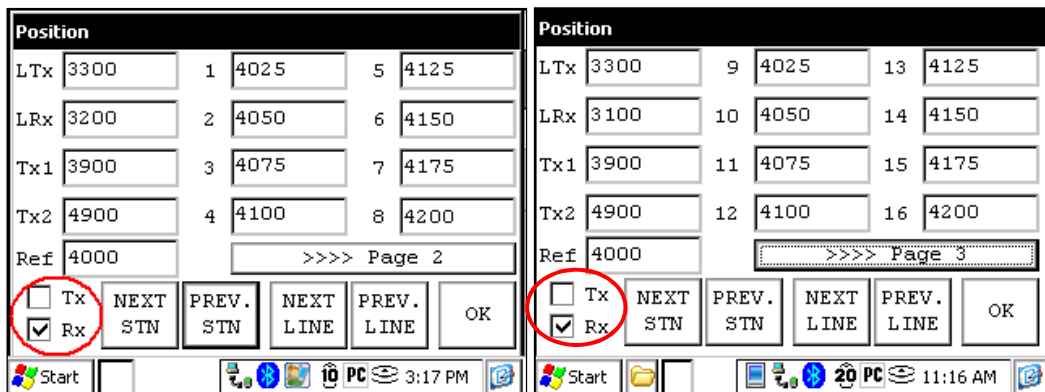

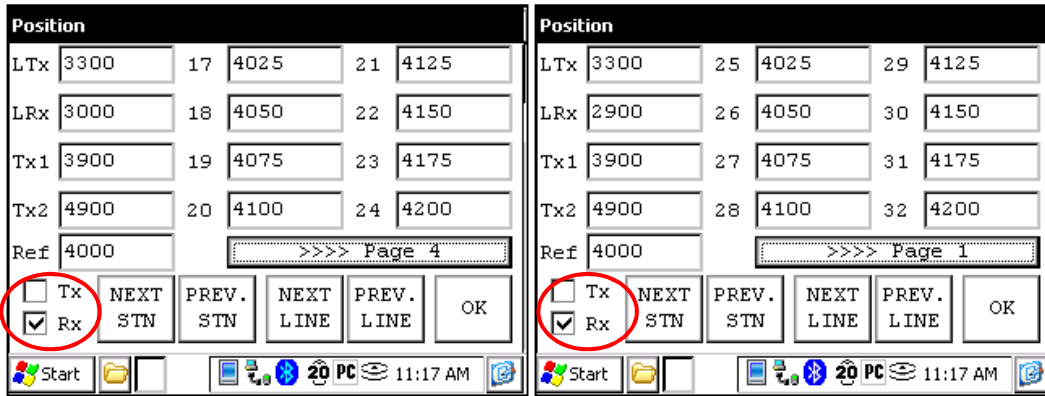

- 4) When the reading is done, make sure that the Tx box is unchecked, click the NEXT STN button to increment the positions. Only the electrodes position on the Receiver will change.
 In this example, you will need to click the NEXT STN button 8 times to be at the position indicated on the next screen.

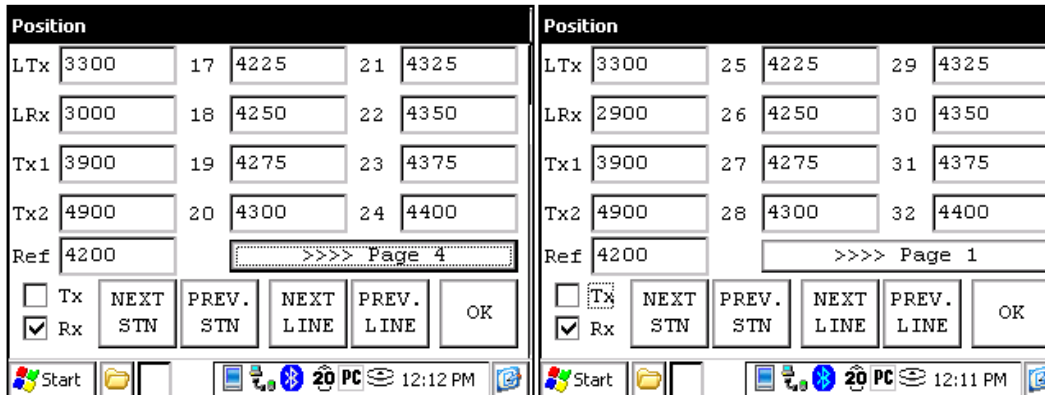
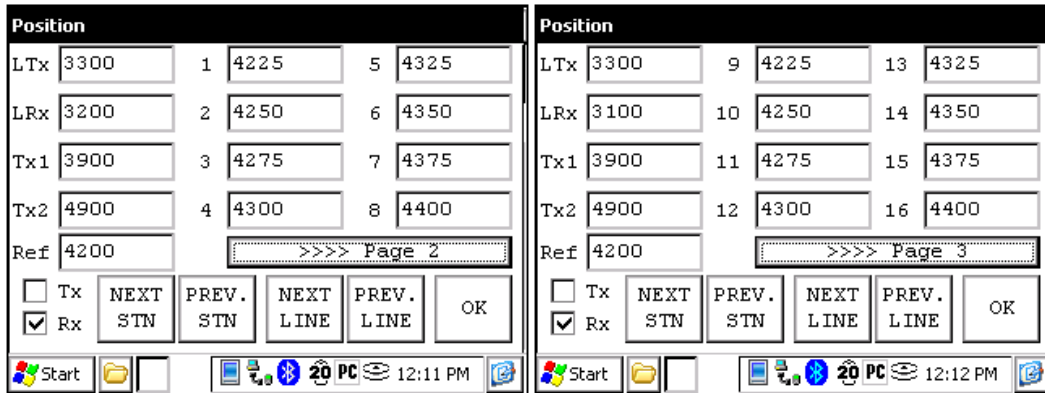

5) Your next setup on the field should be like this.

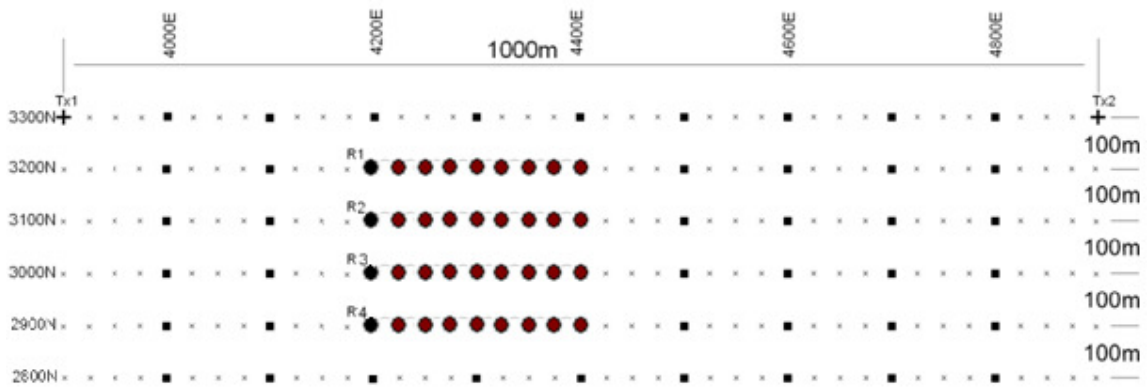

GPS Positions

Setting GPS positions instead of nominal positions

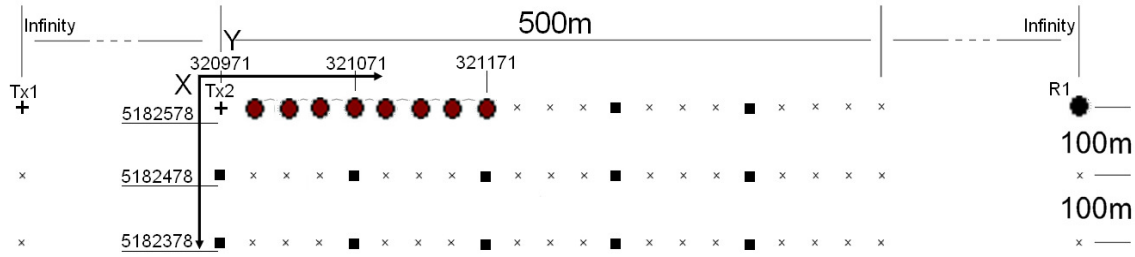

Starting position: X – 320971.52 Easting Y – 5182578.35 Northing

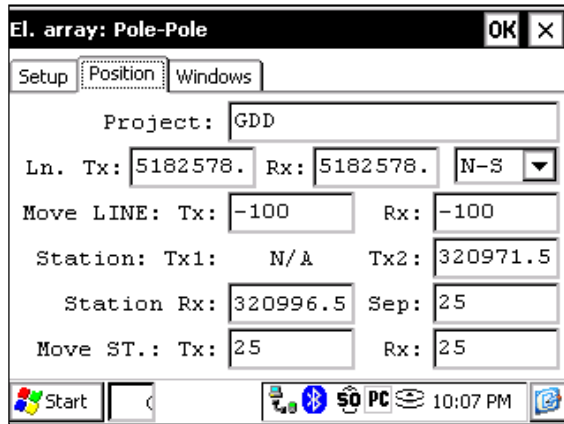

Instead of using a relative position system (the starting position being 0,0), you can enter a GPS position in meters in the Line TX, Line RX, Tx1, Tx2 and Station Rx cases. You can enter any number between -9999999 and 9999999.

Next Station

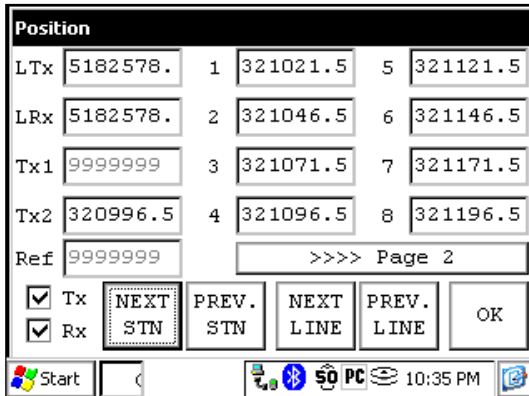

Next Line

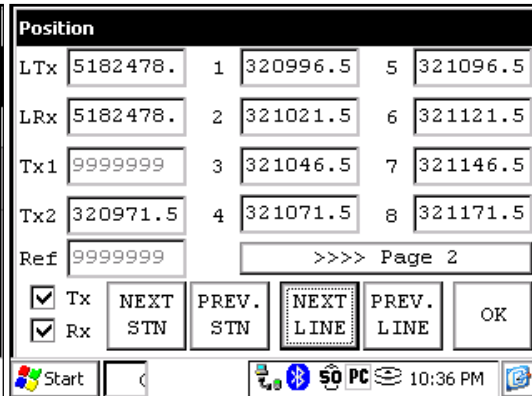

Annex 4 – Example Dump File (.gdd format)

Version PPC: 0.4.2.42 Version Rx: 0.2.5.10 Rx SN: 1309

Project:

Windows: 20 Setting: Arith. Delay (ms): 240 Timing (ms): 80, 80

Mem	Date	Hour	Array	LineTx	LineRx	Dir	n	Tx1	Tx2	Rx1	Rx2	Contact	Rho
1	06/11/2013	08:09:55	P-P	0.00	0.00	N-S	0.0	9999999.00	0.00	0.00	9999999.00	8.9	0.00
1	06/11/2013	08:09:55	P-P	0.00	0.00	N-S	0.0	9999999.00	0.00	0.00	9999999.00	16.0	0.00
1	06/11/2013	08:09:55	P-P	0.00	0.00	N-S	0.0	9999999.00	0.00	0.00	9999999.00	21.2	0.00
1	06/11/2013	08:09:55	P-P	0.00	0.00	N-S	0.0	9999999.00	0.00	0.00	9999999.00	24.2	0.00

Sp	SpMin	SpMax	Vp	ErrVp	Sym(%)	M	ErrM	In	Time	DC	Stack	M01	...
0.4	0.4	0.4	125.112	0.001	100	7.947	0.009	1000.000	2000	50	10	7.974	...
0.5	0.4	0.7	250.336	0.001	100	7.945	0.002	1000.000	2000	50	10	7.954	...
0.7	0.7	0.8	375.726	0.002	100	7.947	0.002	1000.000	2000	50	10	7.961	...
-0.0	-0.1	0.9	500.038	0.002	100	7.945	0.000	1000.000	2000	50	10	7.952	...

First section - File header:

Version PPC:	Version of the Rx program on the PDA
Version Rx:	Version of the Rx firmware
Rx SN:	Serial number of the IP Receiver

Second section:

Project:	Name of your project
----------	----------------------

Third section:

Windows:	Number of windows (depending on the selected mode)
Setting:	Selected mode (Arith., Semi, Log., Cole, User)
Delay (ms):	Delay in ms before the first window (depending on the selected mode)
Timing (ms):	Timing of each window (depending on the selected mode)

- The file is divided in 4 sections. The fourth one contains the data.
- Sections 2 and 3 will be repeated within the same file following a parameter change.
- Infinite values within Rho, TX1 and RX2 (in pole arrays) are represented by 9999999.00.
- Values in section 4 are delimited by one or more spaces. Therefore, the import software must treat consecutive delimiters as one.
- Each line in section 4 has a fix number of entries. If less than 20 windows are defined for a selected entry, the unused columns will be padded with 999.99
- The example file is truncated on the right side omitting column M02 to M20.

Mem	Memory number
Date	Date, format DD/MM/YYYY (date of the PDA when recording the reading)
Hour	Time, format HH:MM:SS (time of the PDA when recording the reading)
Array	Electrode Array; P-P, P-DP, DP-DP, WEN, GRAD
LineTx	Transmitter Line Label
LineRx	Receiver Line Label
Dir	Line Direction (N-S or E-W)
n	Number or Rank of dipole
Tx1	First electrode of the transmitter
Tx2	Second electrode of the transmitter
Rx1	First electrode of the dipole
Rx2	Second electrode of the dipole
Contact	Soil resistance in kOhm; XX.X, INFINI or ----- (undefined)
Rho	Resistivity in Ohm*m
Sp	Self potential in mV
SpMin	Minimum value of SP in mV
SpMax	Maximum value of SP in mV
Vp	Primary voltage in mV
ErrVp	Error of Vp: standard deviation of the data set used to calculate the primary voltage
Sym(%)	Symmetry in %
M	Chargeability in mV/V
ErrM	Error of M: standard deviation of the data set used to calculate the chargeability
In	Current in mA
Time	Transmitter timing in ms
Stack	Number of stacks
DC	Duty Cycle in %
M01 – M20	Windows of chargeability